

Future  
Lighting  
Solution



**GIFFEX LIGHTING CO.,LTD**

559, Second Floor AECS Layout  
C Block Srinivasa Reddy Layout  
AECS Layout Main Road Brookfield,  
Bengaluru - 560037 India

E-mail: [info@giffexlights.com](mailto:info@giffexlights.com),  
[www.giffexlights.com](http://www.giffexlights.com)

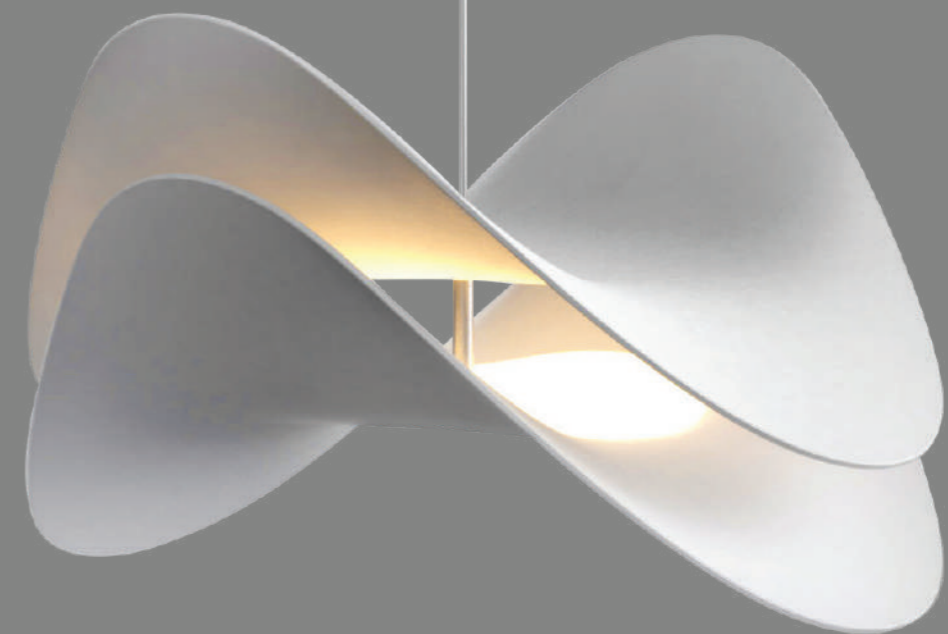

Future  
Lighting  
Solution

Lighting Catalogue



Future  
Lighting  
Solution

Since 1996

Future  
Lighting  
Solution

Giffex

## About Giffex

Founded in 1994, Giffex is a UAE-based lighting industry pioneer with an enduring commitment to quality, innovation, and customer satisfaction. We illuminate spaces with a touch of creativity and sophistication, offering tailored lighting solutions for both residential and commercial needs. Our dedicated team is passionate about understanding your unique requirements, transforming spaces into illuminated works of art. Explore our extensive range and join the Giffex family to experience the transformative power of light.



# Color Rendering Index (CRI)

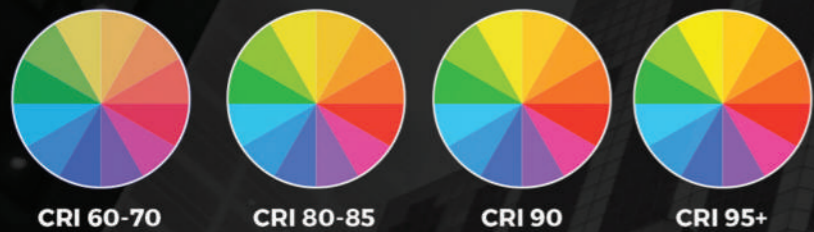

The Color Rendering Index, or CRI, is a valuable tool in the world of lighting. It helps us determine how accurately a light source can display colors when compared to natural sunlight. This index is measured on a scale from 1 to 100, with higher numbers signifying better color rendering abilities.

For example, if a light source boasts a high CRI, typically 80 or above, it means that it excels at rendering colors in a way that closely resembles natural sunlight. In essence, CRI serves as a yardstick for measuring how faith

ful a light source is in illuminating colors as they appear in the great outdoors.

In simple terms, CRI tells us whether a light can paint the world around us with the same vivid and lifelike colors we see in daylight. So, when you encounter a light source with a high CRI, think of it as a trusted artist's brush, faithfully capturing the richness and authenticity of the world's colors. In the world of lighting, CRI ensures that we perceive our surroundings in their true, vibrant hues.

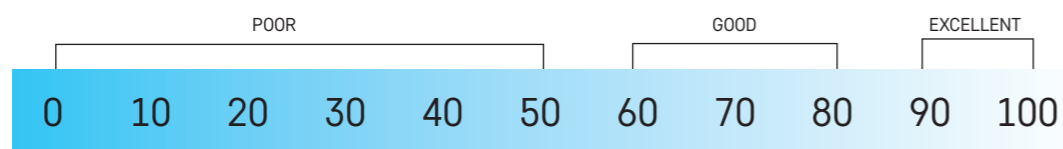

# Beam Angle

The concept of beam angle in lighting might sound complex, but it's essential to understand when choosing the right lighting for your spaces. Simply put, the beam angle determines how wide or narrow the light will spread from the source. This angle is measured in degrees, starting from the light's most intense point and extending to where the light's intensity drops to about 50%. So, when do you opt for a narrow beam angle? Well, think of it as your spotlight. A narrow beam angle concentrates light, making it perfect for accentuating specific areas or highlighting fine details. For instance in your kitchen, you'd want a narrow beam angle over key areas like countertops and, dining tables.

This focused illumination aids in tasks like meal prep, cooking, and cleaning.

On the flip side, when should you embrace a wider beam angle? Picture your lounge room. Here, you don't need intense brightness. Wider

beam angles come into play by distributing light across a more extensive area. This is fantastic when you want to fill a space with light, but you don't need it to be overwhelmingly bright.

That is, beam angles determine how your light spreads, affecting the ambiance and functionality of your space. Understanding beam angles empowers you to make informed choices when selecting lighting fixtures.

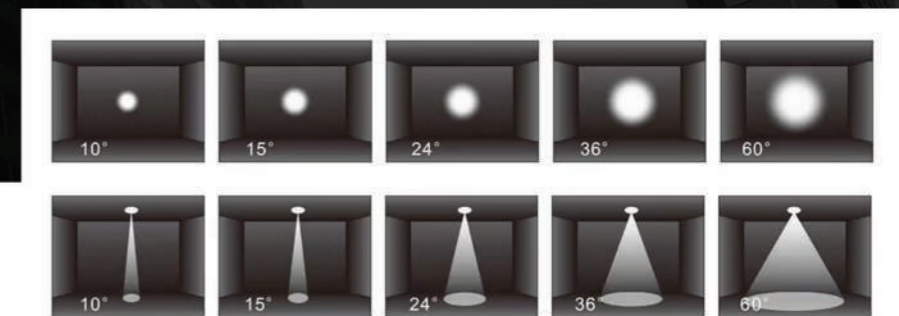

# Color Temperature

Color temperature, measured in Kelvin (K), defines the color of light produced by different light sources. Lower Kelvins (around 2700-3000K) create warm, cozy light, like traditional incandescent bulbs. Higher Kelvins (5000-6500K) yield cool, daylight-like illumination. Understanding color temperature helps you set the right mood, whether in photography, home lighting, or workspaces. In a nutshell, it's about choosing the perfect hue of light for your needs.

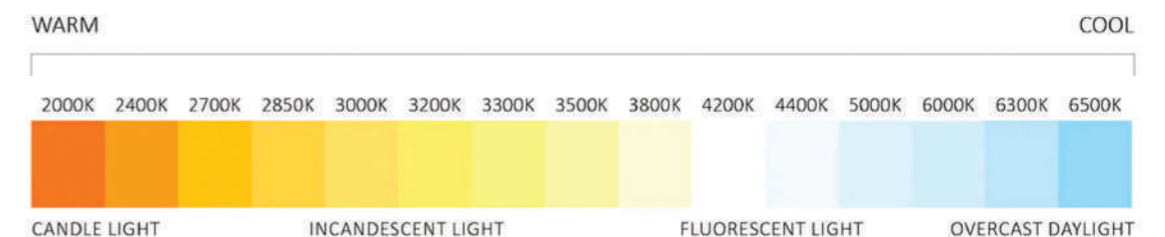

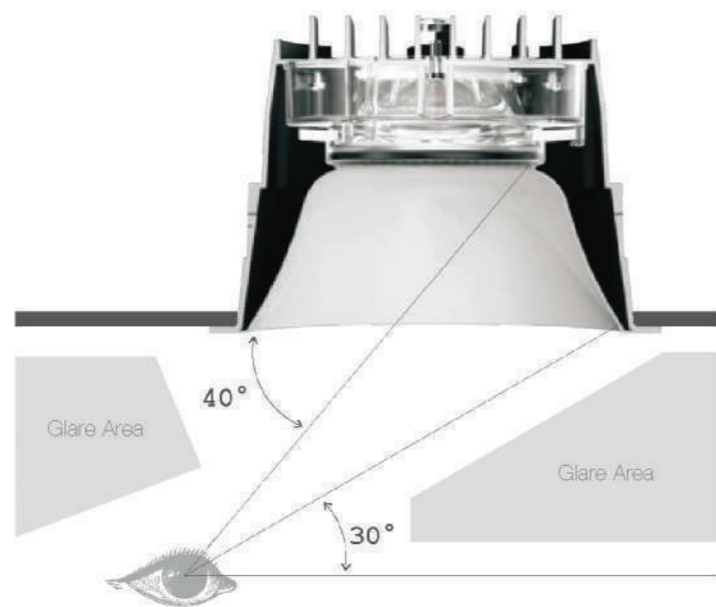

## Anti-Glare

In the realm of lighting, there exists a valuable ally known as "anti-glare" technology, poised to safeguard your vision in environments illuminated by intense lighting sources. Picture yourself within a well-lit office space, where the radiance of artificial lighting can occasionally prove overpowering, causing discomfort and impeding your ability to perceive objects clearly.

This is precisely where anti-glare technology emerges as a solution. Its primary objective is to mitigate the adverse effects of strong light sources by reducing reflections. These reflections, akin to miniature mirrors, have the tendency to redirect light towards your eyes, resulting in visual discomfort.

Anti-glare technology employs a combination of specialized coatings and ingenious design principles to counter this issue effectively. By dispersing light in various directions, it prevents it from bouncing off surfaces and causing glare. This not only enhances visibility but also reduces the strain on your eyes. Therefore, whether you find yourself at work or any other well-illuminated setting, remember that anti-glare technology serves as a faithful guardian of your ocular comfort, ensuring a more pleasant and visually favorable environment.

## COB

In the world of lighting, a revolution is underway, and its name is COB, which stands for Chip on Board. This innovative technology involves mounting multiple LED chips onto a single substrate, creating a single module. The impact is profound. COB LEDs are renowned for their remarkable lumen output despite their small size, making them a sought-after choice for various lighting needs.

One of their standout features is their superior thermal management, ensuring these LEDs remain cool and efficient, even during prolonged use. Unlike traditional LEDs, COB LEDs offer a more consistent and intense light source, making them ideal for applications where uniform illumination is crucial. In summary, COB LEDs are shaping the future of lighting with their compact size, remarkable brightness, and enhanced efficiency.

## Heat Sink/ Heat Dissipation System

When we turn on a light, there's a crucial, yet often overlooked, component at work – the heat sink. In the lighting world, a heat sink is a silent hero, responsible for dissipating the extra heat produced by the light source. Why is this important? Well, it prevents the light fixture from overheating, ensuring both the bulb's longevity and safe operation. This is especially crucial for LED lights, which, despite their efficiency, still generate some heat. Heat sinks come in various designs, from finned to pin and extruded, each effective in dispersing heat. Choosing the right heat sink is vital,

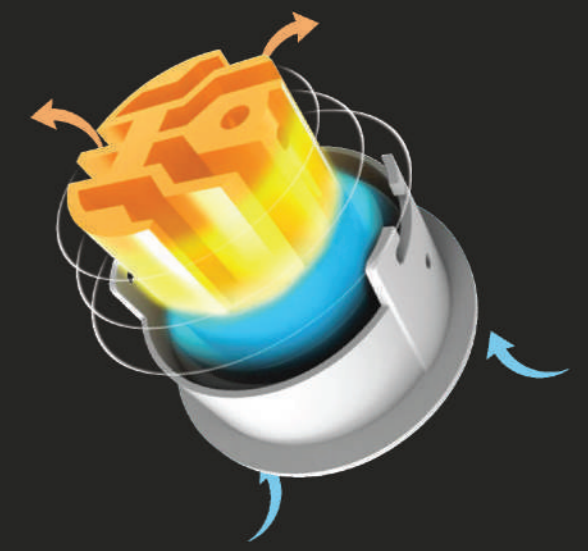

not just for preventing overheating but also for preserving your lighting fixture's performance and lifespan. So, next time you flip the switch, remember the unsung hero quietly working to keep your light shining – the trusty heat sink.

# *Table of* **CONTENTS**

10 LED  
DOWN LIGHT  
Recessed

36 LED  
DOWN LIGHT  
Surface Mounted

46 TRACK LIGHT

70 LED  
LINEAR LIGHT

76 LED  
PANEL LIGHT  
Recessed

84 LED  
PANEL LIGHT  
Surface Mounted

92 LED  
PENDANT LIGHT

106 LED  
CABINET LIGHT

118 LED  
STRIP LIGHT

124 LED  
STEP LIGHT

130 LED  
WALL LIGHT

174 LED  
BOLLARD LIGHT

190 LED  
BULKHEAD LIGHT

191 LED  
BRICK LIGHT

197 LED  
SPIKE LIGHT

199 LED  
INGROUND LIGHT

200 LED  
FLOOD LIGHT

203 LED  
UFO Highbay LIGHT

204 PENDANT LIGHT

207 GARDEN LIGHT



## LED DOWN LIGHT

Recessed

### Series

- This series is an innovative range of professional recessed spotlight fittings created to deliver a high lighting performance with an eye on energy saving and excellent visual comfort
- Modern and stylish design, featuring a strict structure and unique appearance, it aligns perfectly with modern requirements
- A complete, flexible products range, extremely versatile in its many applications and able to meet challenges lighting performance criteria
- Excellent heatsink design, downlights maintain a long life and high efficiency while providing maximum luminous flux
- The color temperature and color rendering index are maintained constant throughout the lifespan



# ARC TRIO

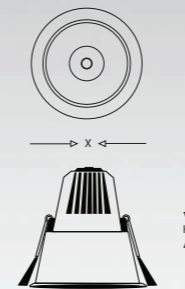

### Features:

- Perfect air convection design and strong thermal conductivity
- Good heat dissipation to ensure the maximum effectiveness of the light source
- High CRI, high light efficiency, and high illumination quality of the LED light source
- High-quality aluminum material and top die-casting process



Gun Black



Matte Silver



Champaign Gold



Bright Black



Bright White



Gold

## CEILING DOWN LIGHT



	7W	12W	18W	
WATTAGE	7W	12W	18W	
SIZE (mm) x	68	89	107	
CUTOUT (mm)	60	75	95	
HEIGHT (mm) H	69	92	107	
LUMEN OUTPUT	C 6500K	700	1200	1800
	N 4000K	700	1200	1800
	W 3000K	700	1200	1800

MATERIAL	ALUMINIUM
CHIP	BRIDGELUX-USA
POWER FACTOR/KV	>0.9/KV>2.5

BEAM ANGLE



38°

BODY COLOUR



CRI

>92

INPUT

AC 150-330V





# ARC TRIO

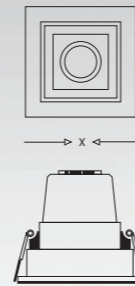
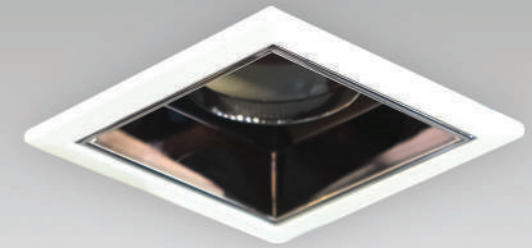

**Features:**

- Perfect air convection design and strong thermal conductivity
- Good heat dissipation to ensure the maximum effectiveness of the light source
- High CRI, high light efficiency, and high illumination quality of the LED light source
- High-quality aluminum material and top die-casting process



Gun Black



Matte Silver



Champaign Gold



Bright Black



Bright White



Gold

## CEILING DOWN LIGHT



WATTAGE	7W	12W	18W	
SIZE (mm) x	68*68	89*89	107*107	
CUTOUT (mm)	60*60	75*75	95*95	
HEIGHT (mm) H	69	92	107	
LUMEN OUTPUT	C 6500K	700	1200	1800
	N 4000K	700	1200	1800
	W 3000K	700	1200	1800

MATERIAL	ALUMINIUM
CHIP	BRIDGELUX-USA
POWER FACTOR/KV	>0.9/kV>2.5

BEAM ANGLE	38°
BODY COLOUR	White Black
CRI	>92
INPUT	AC 150-330V





# DURA

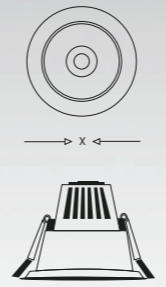

**Features:**

- Deep anti-glare structure designed for the light source
- Very simple and elegant design
- Light source has excellent luminous efficacy
- The light is soft and not dazzling
- Suitable for home, office, shopping malls, hotels, etc



## CEILING DOWN LIGHT



WATTAGE	5W	7W	9W	12W	18W	30W	
SIZE (mm) x	60	60	85	85	100	108	
CUTOUT (mm)	52	52	76	76	88	100	
HEIGHT (mm) h	69	69	80	80	98	120	
LUMEN OUTPUT	C 6500K	400	560	720	960	1440	2400
	N 4000K	400	560	720	960	1440	2400
	W 3000K	400	560	720	960	1440	2400

MATERIAL	ALUMINIUM
CHIP	BRIDGELUX-USA
POWER FACTOR/kV	>0.9/kV>2.5

BEAM ANGLE	40°
BODY COLOUR	White Black
CRI	>80
INPUT	AC 100-265V





# ARC CURVE

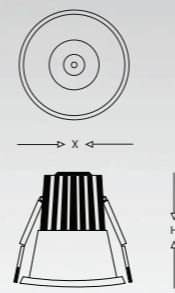

**Features:**

- Simple and elegant.
- High thermal conductivity aluminum for better heat dissipation
- Adopts high-quality optical reflector
- Suitable for home, office, shopping malls, hotels, specialty stores, etc

## CEILING DOWN LIGHT

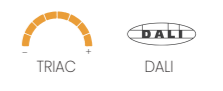

WATTAGE	7W	12W	18W	
SIZE (mm) x	65	80	100	
CUTOUT (mm)	55	75	95	
HEIGHT (mm) H	60	75	95	
LUMEN OUTPUT	C 6500K	700	1200	1800
	N 4000K	700	1200	1800
	W 3000K	700	1200	1800

MATERIAL	ALUMINIUM
CHIP	BRIDGELUX-USA
POWER FACTOR/KV	>0.9/kV>2.5

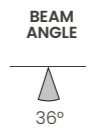

BODY COLOUR	<input type="checkbox"/> White <input type="checkbox"/> Black
CRI	>92
INPUT	AC 150-330V





# ZELO

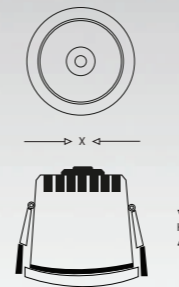

**Features:**

- Simple and elegant appearance design
- Die-cast aluminum lamp body
- Uniform light emission with no dark areas
- Deep anti-dazzle

## CEILING DOWN LIGHT

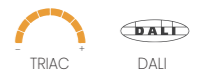

	7W	12W	18W	30W	
<b>WATTAGE</b>	7W	12W	18W	30W	
<b>SIZE (mm) x</b>	83	103	127	154	
<b>CUTOUT (mm)</b>	71	85	110	132	
<b>HEIGHT (mm) H</b>	53	66	77	90	
<b>LUMEN OUTPUT</b>	<b>C</b> 6500K	700	1200	1800	3000
	<b>N</b> 4000K	700	1200	1800	3000
	<b>W</b> 3000K	700	1200	1800	3000

<b>MATERIAL</b>	ALUMINIUM
<b>CHIP</b>	BRIDGELUX-USA
<b>POWER FACTOR/KV</b>	>0.9/kV>2.5

<b>BEAM ANGLE</b>	120°
<b>BODY COLOUR</b>	White <input type="checkbox"/> Black <input type="checkbox"/>
<b>CRI</b>	>90
<b>INPUT</b>	AC 160-265V



# ARC OPTIC

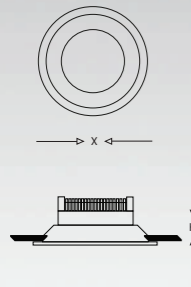

**Features:**

- A sleek design with a high-quality finish
- High luminous efficacy, it can reach up to 100 lm/W
- The light distribution is even, creating soft illumination
- Suitable for hotels, shopping malls, and homes

## CEILING DOWN LIGHT

WATTAGE	9W	12W	18W	24W	30W	
SIZE (mm) x	90	120	155	175	220	
CUTOUT (mm)	75	110	145	165	200	
HEIGHT (mm) H	53	53	58	58	58	
LUMEN OUTPUT	C 6500K	900	1200	1800	2400	3000
	N 4000K	900	1200	1800	2400	3000
	W 3000K	900	1200	1800	2400	3000

MATERIAL	ALUMINIUM + PC
CHIP	SANAN
POWER FACTOR/KV	>0.9/kV>2.5

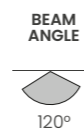

BODY COLOUR	White
CRI	>92
INPUT	AC 150-330V



# ARC OPTIC

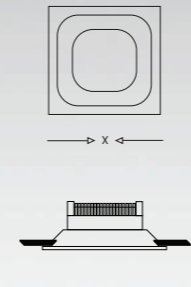

**Features:**

- A sleek design with a high-quality finish
- High luminous efficacy, it can reach up to 100 lm/W
- The light distribution is even, creating soft illumination
- Suitable for hotels, shopping malls, and homes

## CEILING DOWN LIGHT

WATTAGE	12W	18W	24W	
SIZE (mm) L*W	110*110	145*145	170*170	
CUTOUT (mm)	100*100	135*135	160*160	
HEIGHT (mm) H	53	58	58	
LUMEN OUTPUT	C 6500K	1200	1800	2400
	N 4000K	1200	1800	2400
	W 3000K	1200	1800	2400

MATERIAL	ALUMINIUM + PC
CHIP	SANAN
POWER FACTOR/KV	>0.9/kV>2.5

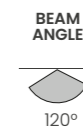

BODY COLOUR	White
CRI	>92
INPUT	AC 150-330V



# BELLEZA

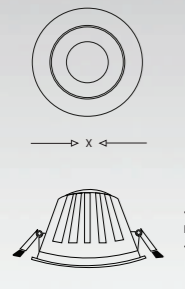

- Features:**
- Sleek design with a high-quality finish
  - High luminous efficacy; it can reach up to 100 lm/W
  - The light distribution is even and creates soft illumination
  - Deep anti-glare design, IP44 Level
  - Widely used in the living room, bedroom, and shopping mall

## CEILING DOWN LIGHT

WATTAGE	7W	10W	15W	20W	30W	
SIZE (mm) x	90	90	120	165	225	
CUTOUT (mm)	70	70	90	145	200	
HEIGHT (mm) H	55	55	70	87	101	
LUMEN OUTPUT	C 6500K	560	800	1500	2000	3000
	N 4000K	560	800	1500	2000	3000
	W 3000K	560	800	1500	2000	3000

MATERIAL	ALUMINIUM
CHIP	EPISTAR
POWER FACTOR/KV	>0.9/kV>2.5

BEAM ANGLE 120°

BODY COLOUR  White

CRI	INPUT
>80	AC 100-265V



# DOLCE

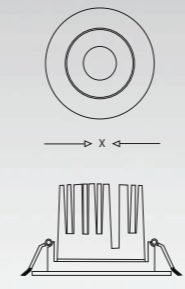

- Features:**
- High-quality aluminum material and top die-casting process
  - Excellent heat sink design
  - High light efficacy and high LED light illumination
  - High-quality COB chip

## CEILING DOWN LIGHT

WATTAGE	3W	6W	9W	12W	16W	
SIZE (mm) x	70	85	100	100	110	
CUTOUT (mm)	60	75	85	85	90	
HEIGHT (mm) H	45	55	58	62	62	
LUMEN OUTPUT	C 6000K	210	480	720	960	1280
	N 4000K	210	480	720	960	1280
	W 3000K	210	480	720	960	1280

MATERIAL	ALUMINIUM
CHIP	BRIDGELUX - USA
POWER FACTOR/KV	>0.6/kV>2.5

BEAM ANGLE 36°

BODY COLOUR  White

CRI	INPUT
>80	AC 100-265V



# GRAZIE MILLE

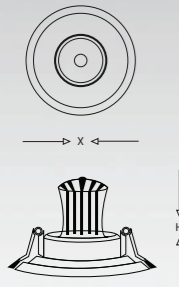

- Features:
- Excellent heat sink design
  - High-quality COB chip
  - Good color quality with Ra > 80
  - Suitable for home and shopping mall

# CEILO

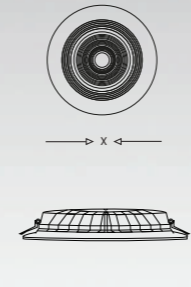

- Features:
- Reliable Material: Die cast aluminium guarantees rust prevention and improve heat dissipation efficiency
  - Space-saving Solution: Ultra-thin LED recessed ceiling light, high brightness
  - The perfect solution for narrow ceilings that are not suitable for can lights

## CEILING DOWN LIGHT

WATTAGE	6W	9W	12W	15W
SIZE (mm) x	85	95	95	100
CUTOUT (mm)	70	80	80	85
HEIGHT (mm) H	83	95	95	95
LUMEN OUTPUT	C 6500K	480	720	960
	N 4000K	480	720	960
	W 3000K	480	720	960

MATERIAL	ALUMINIUM
CHIP	BRIDGELUX - USA
POWER FACTOR/KV	>0.9/kV>2.5

BEAM ANGLE	36°
BODY COLOUR	White
CRI	>80
INPUT	AC 100-265V



## CEILING DOWN LIGHT

WATTAGE	7W	10W	15W	20W	30W
SIZE (mm) x	90	120	160	160	215
CUTOUT (mm)	70	100	140	140	200
HEIGHT (mm) H	35	47	47	47	53
LUMEN OUTPUT	C 6500K	560	800	1500	2000
	N 4000K	560	800	1500	2000
	W 3000K	560	800	1500	2000

MATERIAL	ALUMINIUM
CHIP	BRIDGELUX-USA
POWER FACTOR/KV	>0.9/kV>2.5

BEAM ANGLE	90°
BODY COLOUR	White
CRI	>90
INPUT	AC 100-265V



# LIWA

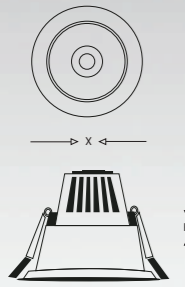

- Features:**
- Deep anti-glare
  - High-quality lumens efficacy
  - Die-cast aluminum material
  - Suitable for hotels, shopping malls, and homes

## CEILING DOWN LIGHT

WATTAGE	3W	7W	12W	
SIZE (mm) x	45	60	85	
CUTOUT (mm)	37	52	73	
HEIGHT (mm) H	46	65	80	
LUMEN OUTPUT	C 6000K	240	560	960
	N 4000K	240	560	960
	W 3000K	240	560	960

MATERIAL	ALUMINIUM	 BEAM ANGLE 40°	BODY COLOUR <input type="checkbox"/> WHITE <input type="checkbox"/> BLACK			
CHIP	BRIDGELUX-USA		<table border="1"> <tr> <th>CRI</th> <th>INPUT</th> </tr> <tr> <td>&gt;80</td> <td>AC 90-265V</td> </tr> </table>	CRI	INPUT	>80
CRI	INPUT					
>80	AC 90-265V					
POWER FACTOR/KV	>0.9/KV>2.5					



# BELLO

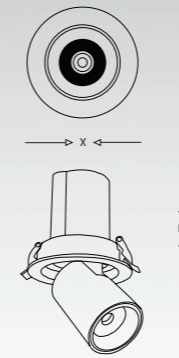

- Features:**
- Telescopic Function: Hidden up and down design with a perfect operational experience to direct the light where you focus
  - Unique construction: 90° tilt and 355° rotation
  - The rotatable downlight is perfect for sloped ceilings, as the LED can pivot and rotate for illumination where you need it

## ADJUSTABLE SPOT LIGHT

WATTAGE	7W	12W	
SIZE (mm) x	91	110	
CUTOUT (mm)	85	90	
HEIGHT (mm) H	98	115	
LUMEN OUTPUT	C 6000K	560	960
	N 4000K	560	960
	W 3000K	560	960

MATERIAL	ALUMINIUM	 BEAM ANGLE 38°	BODY COLOUR <input type="checkbox"/> White			
CHIP	BRIDGELUX-USA		<table border="1"> <tr> <th>CRI</th> <th>INPUT</th> </tr> <tr> <td>&gt;80</td> <td>AC 160-265V</td> </tr> </table>	CRI	INPUT	>80
CRI	INPUT					
>80	AC 160-265V					
POWER FACTOR/KV	>0.9/KV>2.5					





# ISABELLA

## CEILING DOWN LIGHT

### Features:

- Concentrated light, highlighting key points
- Precision die-cast aluminum lamp body
- Anti-rust and improved heat dissipation
- Anti-glare, providing eye protection



BODY COLOUR  White

BEAM ANGLE



CRI	INPUT
>80	AC 100-265V

MATERIAL	ALUMINIUM
CHIP	OSRAM
POWER FACTOR/KV	>0.6/KV>2.5

WATTAGE	5W	10W
SIZE (mm)	x 85	85
CUTOUT (mm)	75	75
HEIGHT (mm)	h 50	50
LUMEN OUTPUT	C 6500K	400
	N 4000K	400
	W 3000K	400

# TERNURA

## CEILING DOWN LIGHT

### Features:

- Concentrated light, highlighting key points
- Precision die-cast aluminum lamp body
- Anti-rust and improved heat dissipation
- Anti-glare, providing eye protection



BODY COLOUR  White

BEAM ANGLE



CRI	INPUT
>80	AC 85-265V

MATERIAL	ALUMINIUM
CHIP	BRIDGEGULEX-USA
POWER FACTOR/KV	>0.8/KV>2.5

WATTAGE	5W	
SIZE (mm)	x 85	
CUTOUT (mm)	70	
HEIGHT (mm)	h 50	
LUMEN OUTPUT	C 6500K	400
	N 4000K	400
	W 3000K	400



# OLIVIA

## CEILING DOWN LIGHT

### Features:

- Concentrated light, highlighting key points
- Precision die-cast aluminum lamp body
- Anti-rust and improved heat dissipation
- Anti-glare, providing eye protection



BODY COLOUR  White

BEAM ANGLE



CRI	INPUT
>80	AC 100-265V

MATERIAL	ALUMINIUM
CHIP	OSRAM
POWER FACTOR/KV	>0.6/KV>2.5

WATTAGE	7W	12W
SIZE (mm)	x 85	85
CUTOUT (mm)	h 75	75
HEIGHT (mm)	80	80
LUMEN OUTPUT	C 6500K	560
	N 4000K	560
	W 3000K	560

# VICTORIA

## CEILING DOWN LIGHT

### Features:

- Concentrated light, highlighting key points
- Precision die-cast aluminum lamp body
- Anti-rust and improved heat dissipation
- Anti-glare, providing eye protection

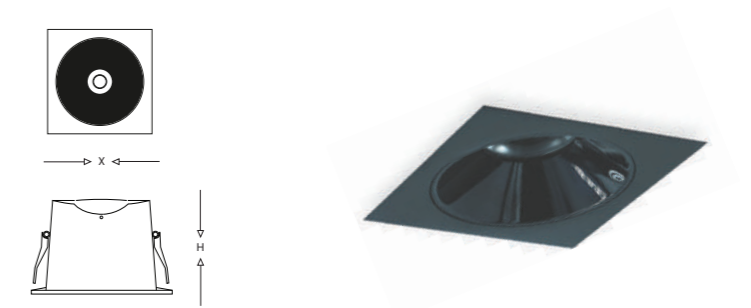

BODY COLOUR  Black

BEAM ANGLE



CRI	INPUT
>80	AC 100-265V

MATERIAL	ALUMINIUM
CHIP	OSRAM
POWER FACTOR/KV	>0.6/KV>2.5

WATTAGE	5W	10W
SIZE (mm)	x 85*85	85*85
CUTOUT (mm)	h 75	75
HEIGHT (mm)	65	65
LUMEN OUTPUT	C 6500K	400
	N 4000K	400
	W 3000K	400



# DOLPHIN

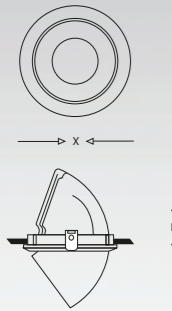

- Features:**
- Intimate pull ring design, convenient for adjustment from various angles
  - 360° rotating adjustment, 75° telescopic adjustment
  - Die cast aluminium material, fine texture, and corrosion resistant
  - High luminous efficacy

# DOLPHIN

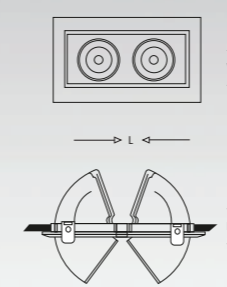

- Features:**
- Intimate pull ring design, convenient for adjustment from various angles
  - 360° rotating adjustment, 75° telescopic adjustment
  - Die cast aluminium material, fine texture, and corrosion resistant
  - High luminous efficacy

## WALL WASHER

WATTAGE	10W	15W	25W	35W	
SIZE (mm) x	90	110	135	160	
CUTOUT (mm)	70	95	115	150	
HEIGHT (mm) H	77	90	100	142	
LUMEN OUTPUT	C 6500K	900	1350	2250	3150
	N 4000K	900	1350	2250	3150
	W 3000K	900	1350	2250	3150

MATERIAL	ALUMINIUM
CHIP	OSRAM
POWER FACTOR/KV	>0.9/kV>2.5

BEAM ANGLE	60°
BODY COLOUR	<input type="checkbox"/> White
CRI	>90
INPUT	AC 85-265V



## WALL WASHER

WATTAGE	2 X 15W	2 X 20W	
SIZE (mm) x	210*114	210*114	
CUTOUT (mm)	194*92	194*92	
HEIGHT (mm) H	100	100	
LUMEN OUTPUT	C 6500K	2700	3600
	N 4000K	2700	3600
	W 3000K	2700	3600

MATERIAL	ALUMINIUM
CHIP	OSRAM
POWER FACTOR/KV	>0.9/kV>2.5

BEAM ANGLE	60°
BODY COLOUR	<input type="checkbox"/> White
CRI	>90
INPUT	AC 85-265V



# NEO ECLIPS

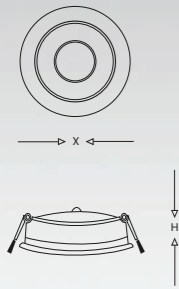
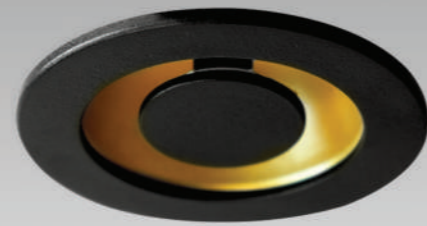

- Features:
- The light-emitting design minimizes glare
  - The light is soft and not dazzling, with no direct light source
  - It can be used as auxiliary lighting

## CEILING DOWN LIGHT

WATTAGE	3W	5W	7W	
SIZE (mm) x	70	85	100	
CUTOUT (mm)	60	70	80	
HEIGHT (mm) H	24.5	31	34	
LUMEN OUTPUT	C 6500K	270	450	630
	N 4000K	270	450	630
	W 3000K	270	450	630

MATERIAL	ALUMINIUM
CHIP	OSRAM
POWER FACTOR/KV	>0.6/kV>2.5

BEAM ANGLE	120°
BODY COLOUR	White Black
CRI	>90
INPUT	AC 100-240V

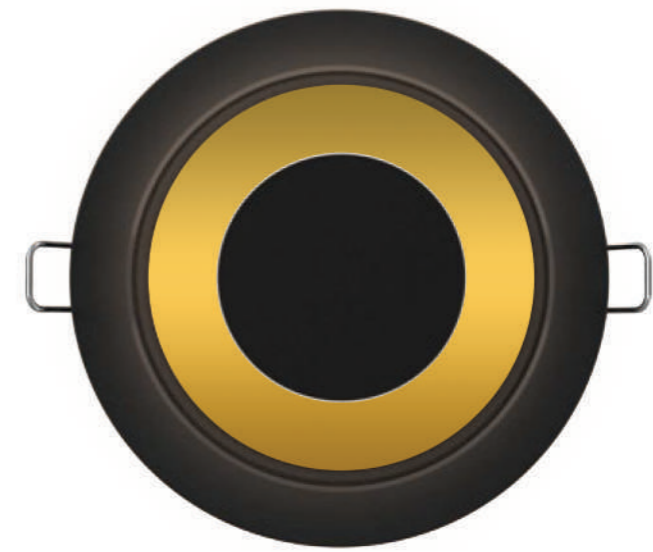



## LED DOWN LIGHT

Surface Mounted

### Series

- This series consists of pendants, surface downlights, spotlights. The idea is to make an ultimate surface downlight, with perfect shape and perfect light
- The series has realized all this purpose, with square shape and round shape. All the above perfectly match the modern house decoration
- Very versatile with its compact and beautiful appearance. It is suitable for both general lighting and accent lighting
- The design of the series and the wide selection of optical angles allow designers to create a distinctive atmosphere and feel

# ARC TRIO

SURFACE DOWN LIGHT

**Features:**

- High quality heat dissipation
- Suitable for building ceilings and ceilings with insufficient space
- High quality LED source
- Narrow edge aluminium material

BODY COLOUR  White  Black

CRI	INPUT
>92	AC 150-330V

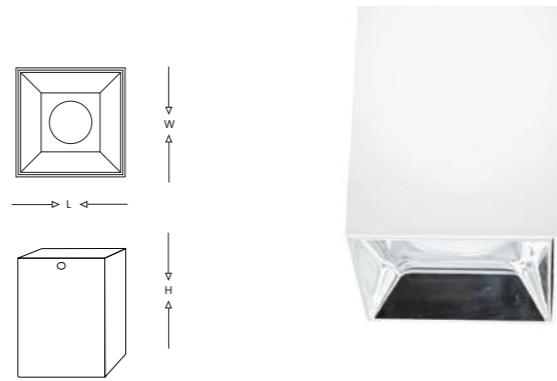
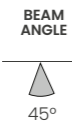

WATTAGE	7W	12W	20W	
SIZE (mm) L*W	55*55	75*75	95*95	
HEIGHT (mm) H	80	100	115	
LUMEN OUTPUT	C 6500K	700	1200	2000
	N 4000K	700	1200	2000
	W 3000K	700	1200	2000

MATERIAL	ALUMINIUM
CHIP	BRIDGELUX - USA
POWER FACTOR/KV	>0.9/KV>2.5



# NUBE

SURFACE DOWN LIGHT

**Features:**

- High quality heat dissipation
- Suitable for building ceilings and ceilings with insufficient space
- High quality LED source
- Narrow edge aluminium material

BODY COLOUR  White  Black

CRI	INPUT
>92	AC 150-330V

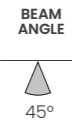

WATTAGE	7W	12W	20W	30W	
SIZE (mm) x	55	75	95	115	
HEIGHT (mm) H	80	100	115	160	
LUMEN OUTPUT	C 6500K	700	1200	2000	3000
	N 4000K	700	1200	2000	3000
	W 3000K	700	1200	2000	3000

MATERIAL	ALUMINIUM
CHIP	BRIDGELUX - USA
POWER FACTOR/KV	>0.9/KV>2.5

**Features:**

- Split design, easy to install
- High quality lumens efficacy
- Die-cast aluminium material
- Suitable for hotels, shopping malls, homes

BODY COLOUR  White  Black

CRI	INPUT
>90	AC 160-265V

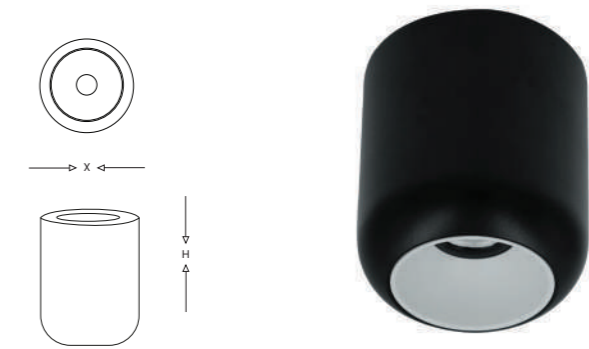
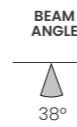

WATTAGE	12W	
SIZE (mm) x	102	
HEIGHT (mm) H	110	
LUMEN OUTPUT	C 6500K	1200
	N 4000K	1200
	W 3000K	1200

MATERIAL	ALUMINIUM
CHIP	BRIDGELUX - USA
POWER FACTOR/KV	>0.9/KV>2.5



# FLORA

## SURFACE DOWN LIGHT

**Features:**

- High quality LED source
- Die-cast aluminium material
- High quality heat dissipation
- Suitable for building ceiling and ceilings with insufficient space

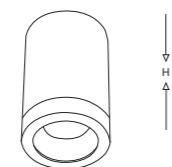
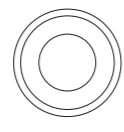

BODY COLOUR  White  BLACK  GREY

BEAM ANGLE



CRI	INPUT
>80	AC 85-265V

WATTAGE	3W	5W
SIZE (mm)	x 35	35
HEIGHT (mm)	H 55	55

MATERIAL	ALUMINIUM
CHIP	BRIDGELUX-USA
POWER FACTOR/KV	>0.5/KV>2.5

LUMEN OUTPUT	N 4000K	240	400
	W 3000K	240	400

# SIERRA

## SURFACE DOWN LIGHT

**Features:**

- High quality LED source
- Die-cast aluminium material
- High quality heat dissipation
- Suitable for building ceiling and ceilings with insufficient space

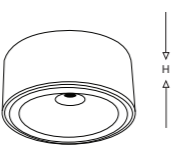
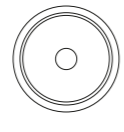

BODY COLOUR  White  BLACK

BEAM ANGLE



CRI	INPUT
>80	AC 100-265V

WATTAGE	7W	10W	20W
SIZE (mm)	x 70	90	110
HEIGHT (mm)	H 40	40	40

MATERIAL	ALUMINIUM
CHIP	SANAN
POWER FACTOR/KV	>0.6/KV>2.5

LUMEN OUTPUT	C 6500K	560	800	1600
	N 4000K	560	800	1600
	W 3000K	560	800	1600

# ZOEY

## SURFACE DOWN LIGHT

**Features:**

- High quality lumens efficacy
- Narrow edge aluminium material
- Simple and elegant design

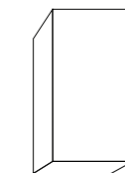
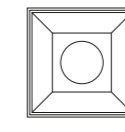

BODY COLOUR  White  BLACK

BEAM ANGLE



CRI	INPUT
>80	AC 85-265V

WATTAGE	5W	7W
SIZE (mm)	L*W 56*56	56*56
HEIGHT (mm)	H 70	104

MATERIAL	ALUMINIUM
CHIP	BRIDGELUX-USA
POWER FACTOR/KV	>0.6/KV>2.5

LUMEN OUTPUT	N 4000K	400	560
	W 3000K	400	560



# ALPHA

## ADJUSTABLE SPOT LIGHT

- Features:**
- Surface mounted design
  - Split design, easy to install
  - Die-cast aluminium body
  - The light is soft and not dazzling



<b>BODY COLOUR</b>	<input type="checkbox"/> White	<b>BEAM ANGLE</b>	
<b>CRI</b>	>90	<b>INPUT</b>	AC 85-265V

<b>MATERIAL</b>	ALUMINIUM
<b>CHIP</b>	OSRAM
<b>POWER FACTOR/KV</b>	>0.9/kV>2.5

<b>WATTAGE</b>	12W
<b>SIZE (mm)</b>	x 90
<b>HEIGHT (mm)</b>	H 100
<b>LUMEN OUTPUT</b>	
<span style="color: blue;">C</span> 6500K	1080
<span style="color: green;">N</span> 4000K	1080
<span style="color: yellow;">W</span> 3000K	1080

# PREGO

## ADJUSTABLE SPOT LIGHT

- Features:**
- Surface mounted design
  - Split design, easy to install
  - Die-cast aluminium body
  - The light is soft and not dazzling

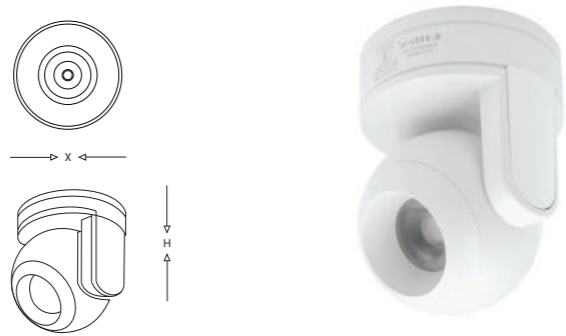

<b>BODY COLOUR</b>	<input type="checkbox"/> White <input checked="" type="checkbox"/> Black	<b>BEAM ANGLE</b>	
<b>CRI</b>	>90	<b>INPUT</b>	AC 85-265V

<b>MATERIAL</b>	ALUMINIUM
<b>CHIP</b>	OSRAM
<b>POWER FACTOR/KV</b>	>0.9/kV>2.5

<b>WATTAGE</b>	12W
<b>SIZE (mm)</b>	x 72
<b>HEIGHT (mm)</b>	H 112
<b>LUMEN OUTPUT</b>	
<span style="color: blue;">C</span> 6500K	1080
<span style="color: green;">N</span> 4000K	1080
<span style="color: yellow;">W</span> 3000K	1080



# GELATTO

## ADJUSTABLE SPOT LIGHT

- Features:**
- Surface mounted design
  - Split design, easy to install
  - Die-cast aluminium body
  - The light is soft and not dazzling



<b>BODY COLOUR</b>	<input type="checkbox"/> White <input checked="" type="checkbox"/> Black	<b>BEAM ANGLE</b>	
<b>CRI</b>	>90	<b>INPUT</b>	AC 85-265V

<b>MATERIAL</b>	ALUMINIUM
<b>CHIP</b>	OSRAM
<b>POWER FACTOR/KV</b>	>0.9/kV>2.5

<b>WATTAGE</b>	10W
<b>SIZE (mm)</b>	L*W 85*85
<b>HEIGHT (mm)</b>	H 88
<b>LUMEN OUTPUT</b>	
<span style="color: blue;">C</span> 6500K	900
<span style="color: green;">N</span> 4000K	900
<span style="color: yellow;">W</span> 3000K	900



# ANGURIA

## ADJUSTABLE SPOT LIGHT

**Features:**

- Modern and simple appearance
- Surface mounted adjustable design
- Die-cast aluminium body
- The light is soft and not dazzling

BODY COLOUR  White  Black

CRI	INPUT
>90	AC 85-265V

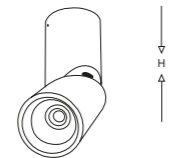
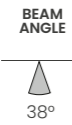

WATTAGE	12W	
SIZE (mm)	x	60
HEIGHT (mm)	H	180
LUMEN OUTPUT	6500K	1080
	4000K	1080
	3000K	1080

MATERIAL	ALUMINIUM
CHIP	BRIDGELUX - USA
POWER FACTOR/KV	>0.9/KV>2.5

# MELA

## ADJUSTABLE SPOT LIGHT

**Features:**

- Surface mounted design
- Split design, easy to install
- Die-cast aluminium body
- The light is soft and not dazzling

BODY COLOUR  BLACK  White

CRI	INPUT
>80	AC 85-265V

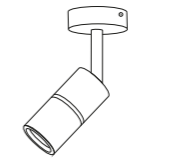

WATTAGE	3W	5W	7W	
SIZE (mm)	x	30	40	50
HEIGHT	H	140	145	160
LUMEN OUTPUT	3000K	240	400	560
	4000K	240	400	560

MATERIAL	ALUMINIUM
CHIP	BRIDGELUX-USA
POWER FACTOR/KV	>0.5/KV>2.5

**Features:**

- Modern and simple appearance
- Surface mounted adjustable design
- Die-cast aluminium body
- The light is soft and not dazzling

BODY COLOUR  White  Black

CRI	INPUT
>90	AC 85-265V

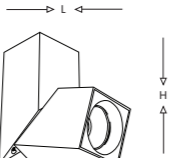
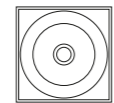
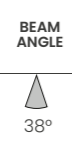

WATTAGE	12W	
SIZE (mm)	L*W	60*60
HEIGHT (mm)	H	180
LUMEN OUTPUT	6500K	1080
	4000K	1080
	3000K	1080

MATERIAL	ALUMINIUM
CHIP	BRIDGELUX - USA
POWER FACTOR/KV	>0.9/KV>2.5

**Features:**

- Surface mounted design
- Split design, easy to install
- Die-cast aluminium body
- The light is soft and not dazzling

BODY COLOUR  BLACK  White

CRI	INPUT
>80	AC 85-265V

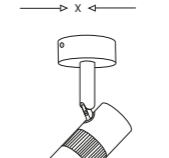

WATTAGE	3W	6W	9W	
SIZE (mm)	x	40	50	60
HEIGHT	H	110	120	130
LUMEN OUTPUT	3000K	240	480	720
	4000K	240	480	720

MATERIAL	ALUMINIUM
CHIP	BRIDGELUX-USA
POWER FACTOR/KV	>0.5/KV>2.5







## TRACK LIGHT

Track lighting is an approach to illumination in which light fixtures are affixed at various points along continuous conductors.

Track lighting can be tailored to suit your specific requirements. The ideal track lighting option for you is the one that aligns with your decor, requirements, and budget. Just determine the way you'd prefer to direct the light.

- Ultra-thin Magnetic Track Light
- Magnetic Track Light
- Traditional Track Light



## ULTRA-THIN TRACK LIGHT

### — Series —

- The Ultra Slim Magnetic Track Light represents a contemporary and practical lighting solution, particularly suitable for spaces where installing lights in a false ceiling is not desired
- With a remarkable thickness of just 5mm, it employs a magnetic system that eliminates the need for a suspended ceiling. This unique feature allows it to be easily cut to any desired length, accommodating various design preferences
- Installation is a breeze, thanks to its user-friendly design featuring brackets and a body lock mechanism. The PC body ensures smooth movement and provides excellent insulation properties

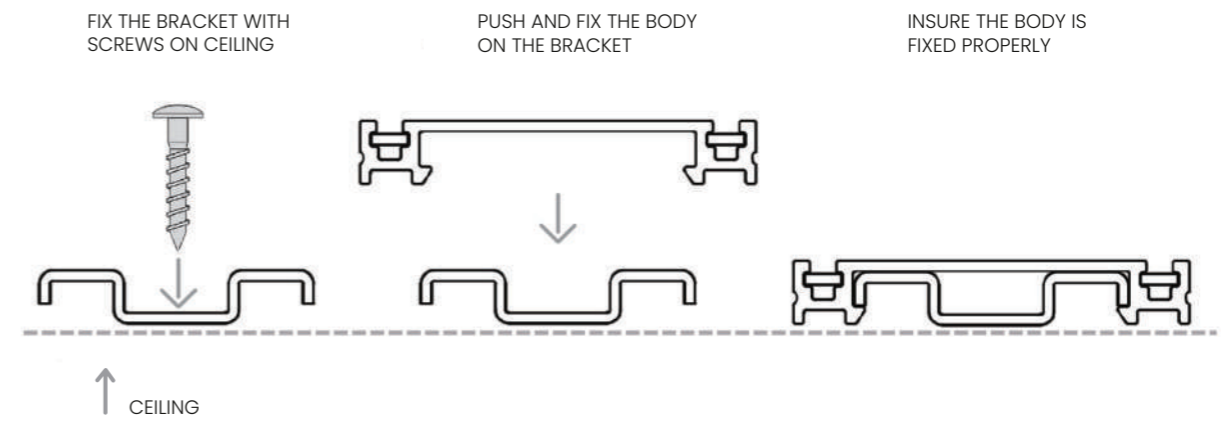

### ULTRATHIN MAGNETIC TRACK

COLOR: BLACK, WHITE  
 INPUT VOLTAGE: DC48V  
 MATERIAL: PC+IRON+COPPER  
 DIMENSION: 30\*5 mm

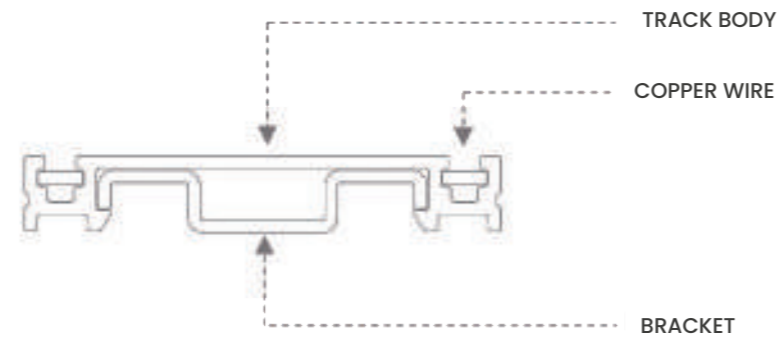

LENGTH: 1000 mm  
 2000 mm  
 3000 mm

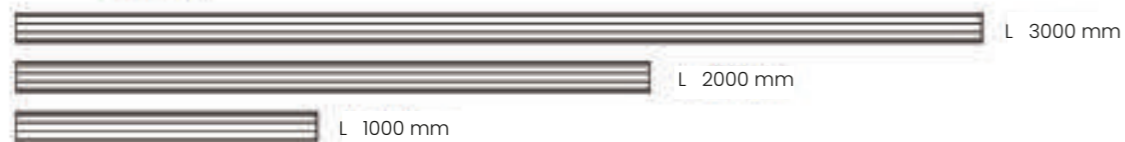

### ICOMET

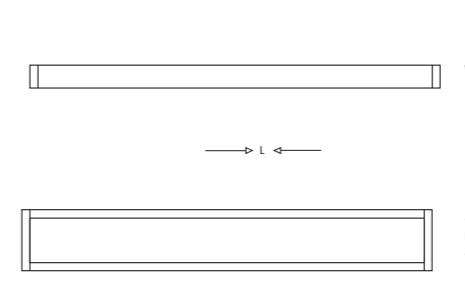

CRI	INPUT	BODY COLOUR	
>90	DC 48V	Black	White



WATTAGE	12W	C 5000K
SIZE	L*W*H 300*32*11	N 4000K
		W 3000K
MATERIAL	ALUMINIUM+POLYCARBONATE	
CHIP	BRIDGELUX-USA	

# I CAMERA

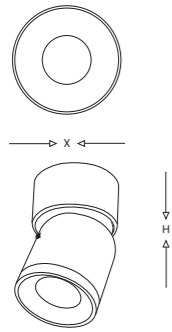

CRI	INPUT	BODY COLOUR	
>90	DC 48V	Black	White



WATTAGE	6W	<span>C</span> 5000K
SIZE	X*H 54*98	<span>N</span> 4000K
		<span>W</span> 3000K
MATERIAL	ALUMINIUM+POLYCARBONATE	
CHIP	BRIDGELUX-USA	

# I HONEY COMB

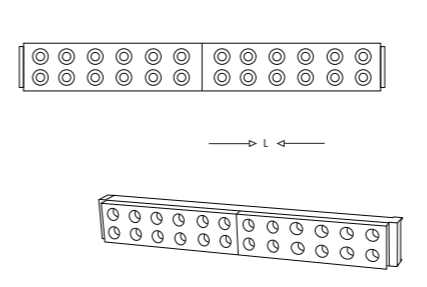

CRI	INPUT	BODY COLOUR	
>90	DC 48V	Black	White



WATTAGE	10W	<span>C</span> 5000K
SIZE	L*W*H 240*32*11	<span>N</span> 4000K
		<span>W</span> 3000K
MATERIAL	ALUMINIUM+POLYCARBONATE	
CHIP	BRIDGELUX-USA	

# I GALAXY

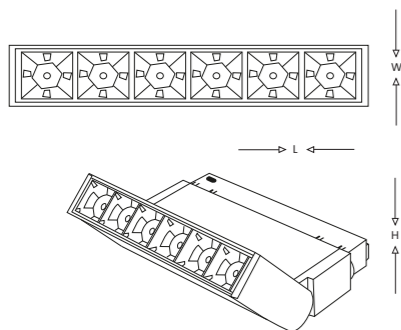

CRI	INPUT	BODY COLOUR	
>90	DC 48V	Black	White



WATTAGE	10W	<span>C</span> 5000K
SIZE	L*W*H 140*35*105	<span>N</span> 4000K
		<span>W</span> 3000K
MATERIAL	ALUMINIUM+POLYCARBONATE	
CHIP	BRIDGELUX-USA	

# I CIRCLE

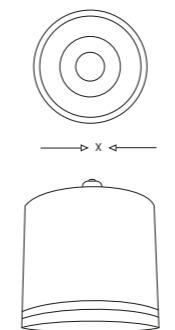

CRI	INPUT	BODY COLOUR	
>90	DC 48V	Black	White



WATTAGE	7W	<span>C</span> 5000K
SIZE	X*H 62*90	<span>N</span> 4000K
		<span>W</span> 3000K
MATERIAL	ALUMINIUM+POLYCARBONATE	
CHIP	BRIDGELUX-USA	

# I STARRAY

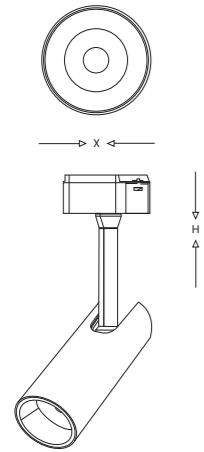

CRI	INPUT	BODY COLOUR	
>90	DC 48V	Black	White



WATTAGE	6W	C 5000K
SIZE	X*H 36*90*145	N 4000K
		W 3000K
MATERIAL	ALUMINIUM+POLYCARBONATE	
CHIP	BRIDGELUX-USA	

# I SHARP

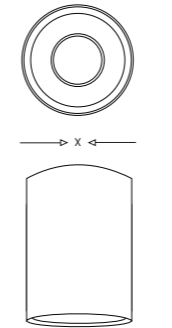

CRI	INPUT	BODY COLOUR	
>90	DC 48V	Black	White



WATTAGE	7W	C 5000K
SIZE	X*H 54*75	N 4000K
		W 3000K
MATERIAL	ALUMINIUM+POLYCARBONATE	
CHIP	BRIDGELUX-USA	

# I GLORY

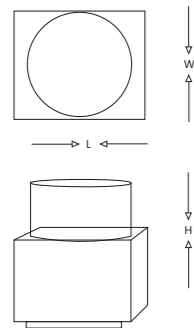

CRI	INPUT	BODY COLOUR	
>90	DC 48V	Black	White



WATTAGE	4W	C 5000K
SIZE	L*W*H 48*35*60	N 4000K
		W 3000K
MATERIAL	ALUMINIUM+POLYCARBONATE	
CHIP	BRIDGELUX-USA	

# I PRIME

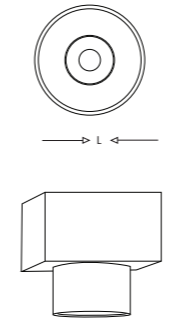

CRI	INPUT	BODY COLOUR	
>90	DC 48V	Black	White



WATTAGE	5W	C 5000K
SIZE	L*W*H 48*35*60	N 4000K
		W 3000K
MATERIAL	ALUMINIUM+POLYCARBONATE	
CHIP	BRIDGELUX-USA	

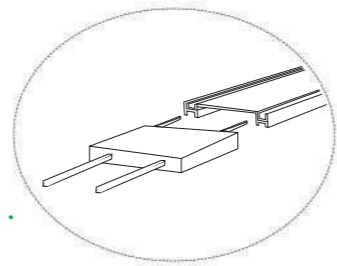

Insert the copper pin of the module in the track under the copper bar

## STRAIGHT CONNECTOR

COLOUR	BLACK, WHITE
MATERIAL	PVC + COPPER
DIMENSION	30*30*5mm

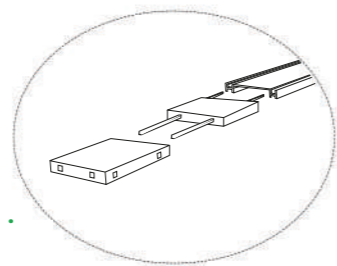
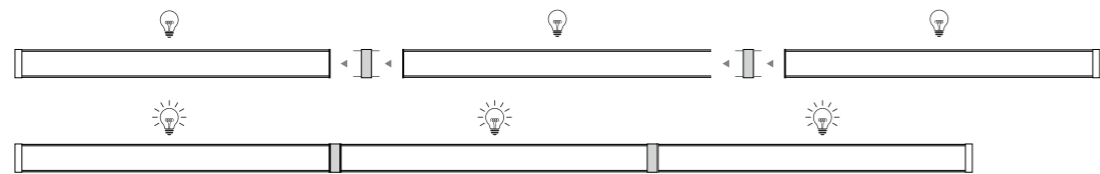

Insert the copper pin of the module in the track under the copper bar

## CROSS CONNECTOR

COLOUR	BLACK, WHITE
MATERIAL	PVC + COPPER
DIMENSION	30*30*5mm

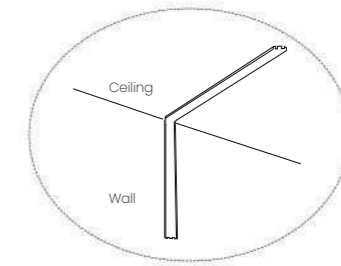
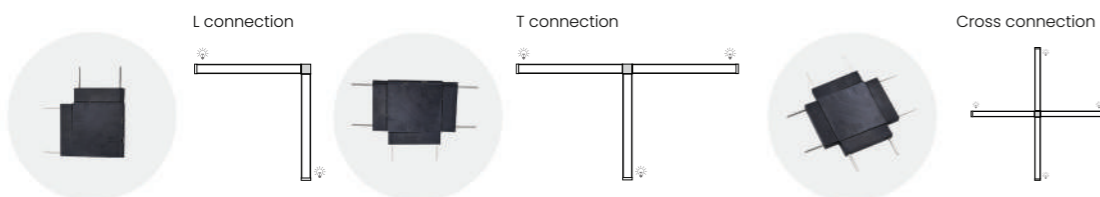

## VERTICAL CONNECTOR

COLOUR	BLACK, WHITE
MATERIAL	PVC + COPPER
DIMENSION	30*30*25mm

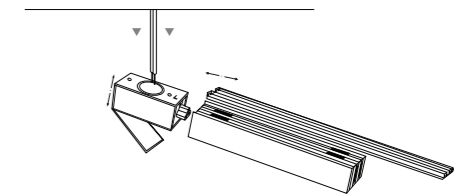

## POWER SUPPLY

COLOUR	BLACK, WHITE
INPUT VOLTAGE	AC 190-245V
DIMENSION	32*31*282mm(100W) 32*31*352mm(200W)



## MAGNETIC TRACK LIGHT

### Series

- Magnetic track lights represent the latest trend in flexible track lighting. They feature a magnetic track channel that allows lights to be effortlessly attached or detached. This versatile system offers numerous attachments and can even be completely concealed within a false ceiling, adding an appealing aesthetic touch to interiors.
- These lights come in suspended, surface-mounted, and recessed versions, providing flexibility to suit your needs.
- Options for lengths include 1.0, 2.0, and 3.0 meters, making them adaptable for various spaces. Crafted from extruded aluminum alloy profiles, these tracks exhibit exceptional thermal conductivity. The stoving varnish finish enhances their surface quality.



## I OASIS

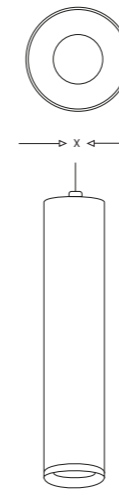

CRI	INPUT	BODY COLOUR	BEAM ANGLE	
>90	DC 48V	Black	36°	<span>N</span> 4000K <span>W</span> 3000K



WATTAGE	6W	12W
SIZE	x*H 30*300	60*300
MATERIAL	ALUMINIUM	
CHIP	OSRAM	

## I RECESSED MAGNETIC TRACK CHANNEL

MATERIAL	ALUMINIUM
SIZE	1m, 2m, 3m
BODY COLOUR	BLACK
VOLTAGE	DC48V

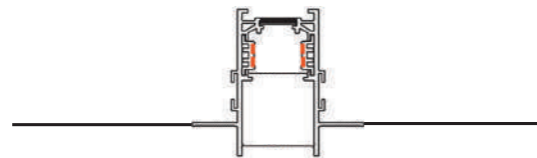

## I SURFACE MAGNETIC TRACK CHANNEL

MATERIAL	ALUMINIUM
SIZE	1m, 2m, 3m
BODY COLOUR	BLACK
VOLTAGE	DC48V

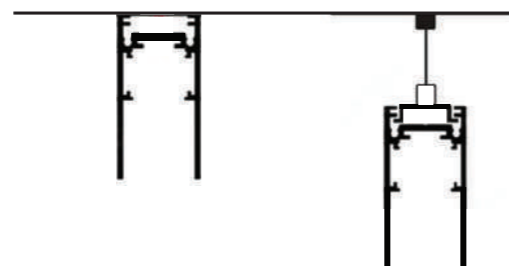

## I AISLE

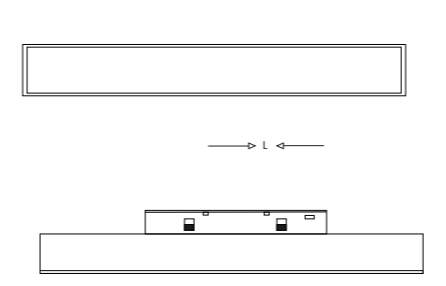

CRI	INPUT	BODY COLOUR	BEAM ANGLE
>90	DC 48V	Black	100°



WATTAGE	10W	20W	30W
SIZE	L*W*H 300*20*45	600*20*45	900*20*45
MATERIAL	ALUMINIUM+PC		<span>N</span> 4000K <span>W</span> 3000K
CHIP	OSRAM		





# INANO

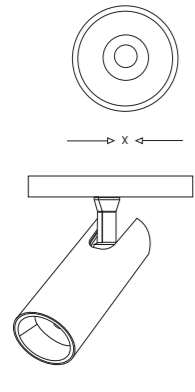

WATTAGE	7W	12W	18W
SIZE L*W*H	90*40	120*40	135*50
MATERIAL	ALUMINIUM		
CHIP	OSRAM		
			N 4000K W 3000K

CRI	INPUT	BODY COLOUR
>90	DC 48V	Black



# IVOUGUE

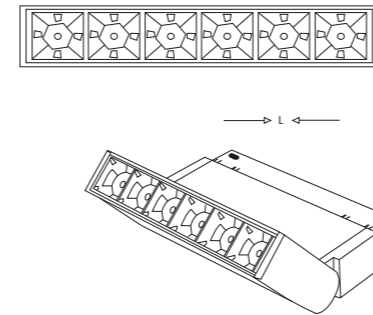

CRI	INPUT	BODY COLOUR	BEAM ANGLE
>90	DC 48V	Black	36°

N 4000K W 3000K
--------------------



WATTAGE	6W	12W
SIZE L*W*H	110*20*105	220*20*105
MATERIAL	ALUMINIUM	
CHIP	OSRAM	

# IGENI

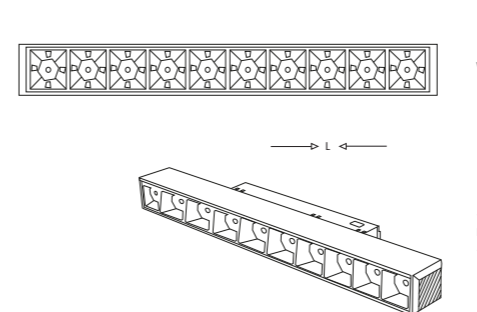

CRI	INPUT	BODY COLOUR	BEAM ANGLE
>90	DC 48V	Black	36°

WATTAGE	6W	12W	18W	24W
SIZE L*W*H	110*20*45	220*20*45	330*20*45	440*20*45
MATERIAL	ALUMINIUM			
CHIP	OSRAM			
			N 4000K W 3000K	



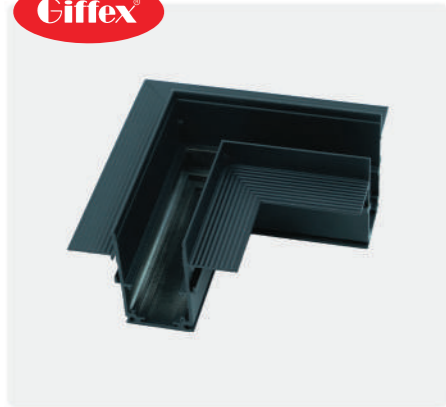

COLOUR	BLACK
MATERIAL	ALUMINIUM
DIMENSION	100*100*H50mm

## CORNER FITTING

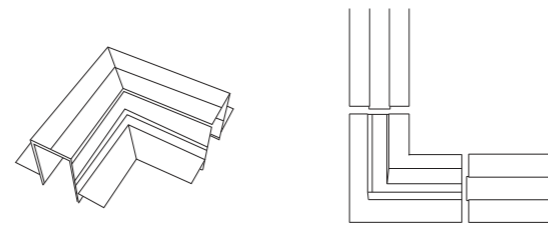

MATERIAL	ALUMINIUM
DIMENSION	2mtr

## SUSPENSION KIT

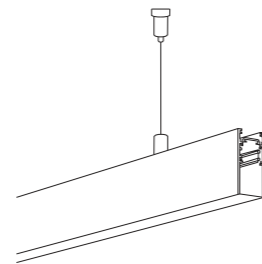

COLOUR	BLACK
MATERIAL	ALUMINIUM+PC
DIMENSION	130*17*20mm

## STRAIGHT CONNECTOR

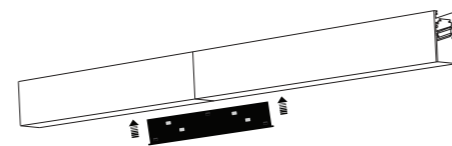

COLOUR	BLACK
MATERIAL	ALUMINIUM+PC
DIMENSION	370*17*20mm

## BEND JOINT

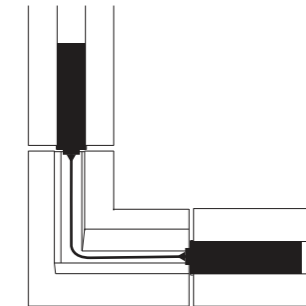

WATTAGE	100W , 200W
COLOUR	BLACK
MATERIAL	ALUMINIUM+PC
DIMENSION	100W-225*22*45mm 200W-300*22*45mm

## POWER SUPPLY

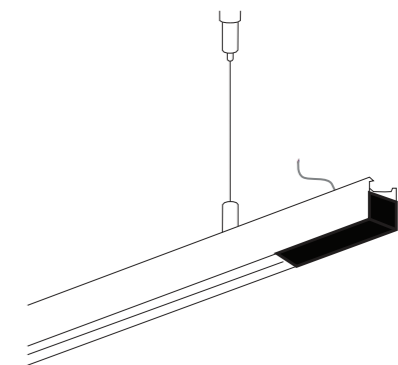



## TRADITIONAL TRACK LIGHT

### — Series —

- Featuring impeccable optical design, precision-injected reflectors, and vacuum-plated surfaces.
- Versatile Style: Its understated design is universally appealing, seamlessly blending into various environments.
- The track spotlight provides extensive options for beam angles, color temperatures, color rendering, and optical enhancements.
- Make the colours POP: Perfect colour match gets better reproduction across the spectrum.

# TRADITIONAL TRACK LIGHT

## IAVIN

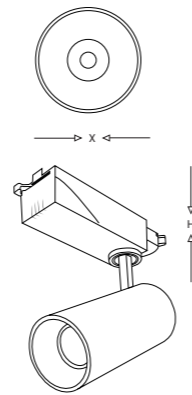

- Features:
- Excellent performance.
  - Multiple installation.
  - Competitive construction with high quality.
  - Die-cast aluminum body.

WATTAGE	7W	10W	20W	30W
SIZE	50*158	50*128	66*158	73*160
LUMEN OUTPUT	C 6500K	700	1000	2000
	N 4000K	700	1000	2000
	W 3000K	700	1000	2000

MATERIAL	ALUMINIUM
CHIP	BRIDGELUX-USA
POWER FACTOR/KV	>0.9/KV>2.5

CRI	INPUT	BODY COLOUR
>92	AC 150-330V	Black



## IFIONA

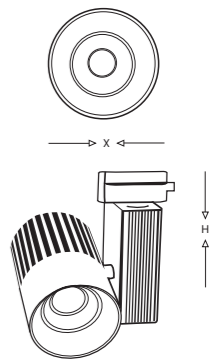

- Features:
- Excellent performance.
  - Multiple installation.
  - Competitive construction with high quality.
  - Die-cast aluminum body.

WATTAGE	30W	50W
SIZE	100*210	100*210
LUMEN OUTPUT	C 5000K	3000
	N 4000K	3000
	W 3000K	3000

MATERIAL	ALUMINIUM
CHIP	BRIDGELUX-USA
POWER FACTOR/KV	>0.9/KV>2.5

CRI	INPUT	BODY COLOUR
>80	AC 85-265V	Black





## LED LINEAR LIGHT

### Series

- LED panel light is one of the most popular luminaire for commercial lighting
- Sealed lamp body design
- LED panel lamp adopts the reflective panel and sealed design with uniform luminance
- LED panel lights can adjust light color according to different needs and environmental changes, not only no radiation and dazzling light generation, but also can protect vision, light color is more mild

# SAKURA

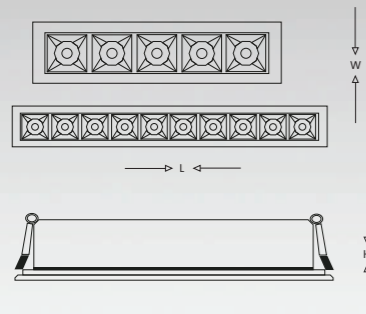

**Features:**

- Precision die-cast aluminum lamp body
- Anti-rust and better heat dissipation
- Black micro grille design
- Anti-glare eye protection

## RECESSED LINEAR LIGHT

WATTAGE	5W	12W	20W	40W	
SIZE (mm) L*W	55*55	130*55	205*55	395*55	
CUTOUT (mm)	46*46	123*46	200*46	390*46	
HEIGHT (mm) H	45	45	45	45	
LUMEN OUTPUT	C 6500K	500	1200	2000	4000
	N 4000K	500	1200	2000	4000
	W 3000K	500	1200	2000	4000

MATERIAL	ALUMINIUM
CHIP	OSRAM
POWER FACTOR/KV	>0.9/kV>2.5

BEAM ANGLE	38°
BODY COLOUR	BLACK White
CRI	>90
INPUT	AC 85-265V



# SAKURA

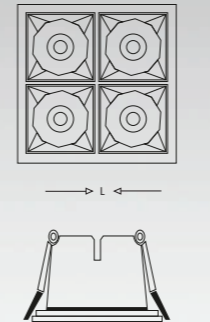

**Features:**

- Precision die-cast aluminum lamp body
- Anti-rust and better heat dissipation
- Black micro grille design
- Anti-glare eye protection

## RECESSED LINEAR LIGHT

WATTAGE	16W	36W	
SIZE (mm) L*W	93*93	130*130	
CUTOUT (mm)	86*84	124*122	
HEIGHT (mm) H	45	45	
LUMEN OUTPUT	C 6500K	1600	3600
	N 4000K	1600	3600
	W 3000K	1600	3600

MATERIAL	ALUMINIUM
CHIP	OSRAM
POWER FACTOR/KV	>0.9/kV>2.5

BEAM ANGLE	38°
BODY COLOUR	White BLACK
CRI	>90
INPUT	AC 85-265V



# ROYCE

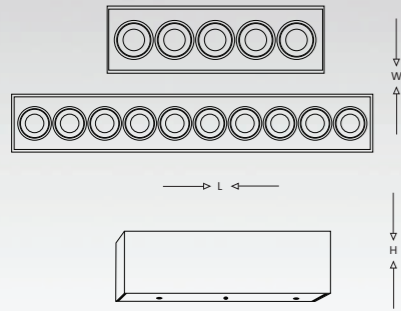

**Features:**

- High grade aluminum, frosted process.
- Micro grille design, anti-glare eye protection
- Strip design, small space ratio

## SURFACE LINEAR LIGHT

WATTAGE		15W	20W
SIZE (mm)	L*W	137*34	269*34
HEIGHT (mm)	H	44	44

LUMEN OUTPUT	C 6500K	1500	2000
	N 4000K	1500	2000
	W 3000K	1500	2000

MATERIAL	ALUMINIUM
CHIP	BRIDGELUX-USA
POWER FACTOR/KV	>0.9/KV>2.5

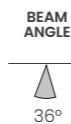

BODY COLOUR	BLACK
CRI	>90
INPUT	AC 160-265V



# LUMINO



## LINEAR HANGING LIGHT

**Features:**

- Ceiling and hanging wire installation are optional, suitable for all kinds of ceilings
- High-brightness and durable high-quality chips, high light efficiency, low light decay and long life
- Aluminum matte texture, corrosion resistance and oxidation resistance, good heat dissipation performance

WATTAGE	48W
CCT	W N C
CRI	>80
INPUT VOLTAGE	110-265V
DIMENSION	1185*50*75 mm
CHIP	SANAN SMD
COLOUR	BLACK





## LED PANEL LIGHT

Recessed

### Series

- LED panel light is one of the most popular luminaire for commercial lighting.
- Sealed lamp body design.
- LED panel lamp adopts the reflective panel and sealed design with uniform luminance
- LED panel lights can adjust light color according to different needs and environmental changes, not only no radiation and dazzling light generation, but also can protect vision, light color is more mild.



# PRISMA

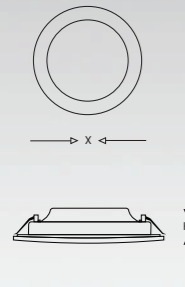

- Features:**
- Slim Backlit LED Downlight
  - DOB Integrated LED Module engine for Optimal Performance
  - Crafted from Durable Engineering PC Material
  - Your Space-Saving Lighting Solution

## PANEL LIGHT

WATTAGE	3W	6W	9W	15W	22W	
SIZE (mm) x	88	116	116	166	220	
CUTOUT (mm)	70	105	105	155	205	
HEIGHT (mm) H	36	36	36	36	36	
LUMEN OUTPUT	C 6500K	300	600	900	1500	2200
	N 4000K	300	600	900	1500	2200
	W 3000K	300	600	900	1500	2200

MATERIAL	POLYCARBONATE
CHIP	SANAN
POWER FACTOR/KV	>0.88/KV>2.5

BEAM ANGLE	120°
BODY COLOUR	White
CRI	>92
INPUT	AC 100-265V



# PRISMA

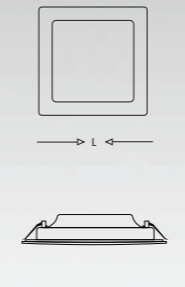

- Features:**
- Slim Backlit LED Downlight
  - DOB Integrated LED Module engine for Optimal Performance
  - Crafted from Durable Engineering PC Material
  - Your Space-Saving Lighting Solution

## PANEL LIGHT

WATTAGE	3W	6W	9W	15W	22W	
SIZE (mm) L*W	88*88	116*116	116*116	166*166	220*220	
CUTOUT (mm)	70*70	105*105	105*105	155*155	205*205	
HEIGHT (mm) H	36	36	36	36	36	
LUMEN OUTPUT	C 6500K	300	600	900	1500	2200
	N 4000K	300	600	900	1500	2200
	W 3000K	300	600	900	1500	2200

MATERIAL	POLYCARBONATE
CHIP	SANAN
POWER FACTOR/KV	>0.88/KV>2.5

BEAM ANGLE	120°
BODY COLOUR	White
CRI	>92
INPUT	AC 100-265V



# HARMONY

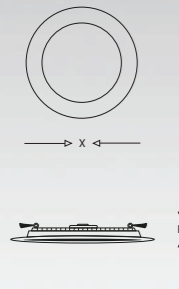

- Features:**
- Elegant Aluminum Panel with a Streamlined Design
  - Superior-Quality Finish
  - Efficient Cooling System for Extended Lifespan and no yellowing
  - Premium-Grade Driver and LED Technology

## SLIM PANEL LIGHT

WATTAGE	3W	6W	9W	12W	15W	18W	
SIZE (mm) x	90	120	145	172	172	255	
CUTOUT (mm)	80	110	135	150	150	210	
HEIGHT (mm) H	17	17	17	17	17	17	
LUMEN OUTPUT	● 6500K	240	480	720	960	1200	1440
	● 4000K	240	480	720	960	1200	1440
	● 3000K	240	480	720	960	1200	1440

MATERIAL	ALUMINIUM
CHIP	EPISTAR
POWER FACTOR/KV	>0.9/kV>2.5

BEAM ANGLE 120°

BODY COLOUR  White

CRI	INPUT
>80	AC 85-265V



# HARMONY

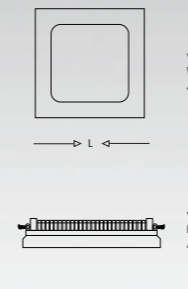

- Features:**
- Elegant Aluminum Panel with a Streamlined Design
  - Superior-Quality Finish
  - Efficient Cooling System for Extended Lifespan and no yellowing
  - Premium-Grade Driver and LED Technology

## SLIM PANEL LIGHT

WATTAGE	3W	6W	9W	12W	15W	18W	
SIZE (mm) L*W	90*90	120*120	145*145	172*172	172*172	255*255	
CUTOUT (mm)	80*80	110*110	135*135	150*150	150*150	210*210	
HEIGHT (mm) H	17	17	17	17	17	17	
LUMEN OUTPUT	● 6500K	240	480	720	960	1200	1440
	● 4000K	240	480	720	960	1200	1440
	● 3000K	240	480	720	960	1200	1440

MATERIAL	ALUMINIUM
CHIP	EPISTAR
POWER FACTOR/KV	>0.9/kV>2.5

BEAM ANGLE 120°

BODY COLOUR  White

CRI	INPUT
>80	AC 85-265V



# MERCURY

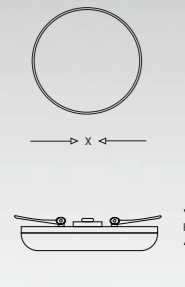

- Features:
- Cutout size adjustable
  - Integrated structure
  - Engineering PC material
  - Half-curved optical design

## PANEL LIGHT

WATTAGE	8W	18W	24W	32W	
SIZE (mm) x	85	120	170	225	
CUTOUT (mm)	72	105	155	205	
HEIGHT (mm) H	20	20	20	20	
LUMEN OUTPUT	C 6500K	720	1620	2160	2880
	N 4000K	720	1620	2160	2880
	W 3000K	720	1620	2160	2880

MATERIAL	ALUMINIUM + PC
CHIP	EPISTAR
POWER FACTOR/KV	>0.9/KV>2.5

BEAM ANGLE	120°
BODY COLOUR	White
CRI	>80
INPUT	AC 100-265V



# MERCURY

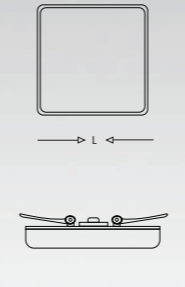
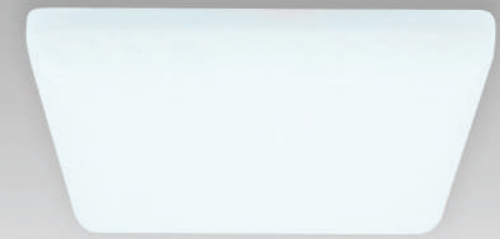

- Features:
- Cutout size adjustable
  - Integrated structure
  - Engineering PC material
  - Half-curved optical design

## PANEL LIGHT

WATTAGE	8W	18W	24W	32W	
SIZE (mm) L*W	85*85	120*120	170*170	225*225	
CUTOUT (mm)	72*72	105*105	155*155	205*205	
HEIGHT (mm) H	20	20	20	20	
LUMEN OUTPUT	C 6500K	720	1620	2160	2880
	N 4000K	720	1620	2160	2880
	W 3000K	720	1620	2160	2880

MATERIAL	ALUMINIUM + PC
CHIP	EPISTAR
POWER FACTOR/KV	>0.9/KV>2.5

BEAM ANGLE	120°
BODY COLOUR	White
CRI	>80
INPUT	AC 100-265V





## LED PANEL LIGHT

Surface Mounted

### — Series —

- LED surface mounted panel lights can be made in shape or size to replace almost all existing applications
- Using Semi-Conductor light source, no UV Rays. Extensive application, simple, safe, and convenient. LED surface mounted panel light can work perfect in low temperature
- Products offer low-energy, low maintenance, low-heat, long life operation, and provide significant savings on electricity and maintenance

# RIVA

## SURFACE PANEL LIGHT

### Features:

- Engineering PC material
- Boundless luminous design
- Ultra-thin ceiling installation
- Simple and fashionable



BODY COLOUR  White

BEAM ANGLE



CRI	INPUT
>80	AC 100-265V

MATERIAL	POLYCARBONATE
CHIP	SANAN
POWER FACTOR/KV	>0.9/KV>2.5

	WATTAGE	8W	15W	22W
SIZE (mm)	x	100	140	180
HEIGHT (mm)	H	30	30	30
LUMEN OUTPUT	C 6500K	640	1200	1760
	N 4000K	640	1200	1760
	W 3000K	640	1200	1760

### Features:

- Engineering PC material
- Boundless luminous design
- Ultra-thin ceiling installation
- Simple and fashionable



BODY COLOUR  White

BEAM ANGLE



CRI	INPUT
>80	AC 100-265V

MATERIAL	POLYCARBONATE
CHIP	SANAN
POWER FACTOR/KV	>0.9/KV>2.5

	WATTAGE	8W	15W	22W
SIZE (mm)	L*W	100*100	140*140	180*180
HEIGHT (mm)	H	30	30	30
LUMEN OUTPUT	C 6500K	640	1200	1760
	N 4000K	640	1200	1760
	W 3000K	640	1200	1760



# VIOLA

## SURFACE PANEL LIGHT

### Features:

- Simple and convenient installation
- Soft light eye protection
- High illuminated light source
- High quality PC material



BODY COLOUR  White

CRI	INPUT
>80	AC 85-265V

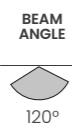

MATERIAL	POLY CARBONATE
CHIP	SANAN
POWER FACTOR/KV	>0.9/KV>2.5

	WATTAGE	18W	24W	36W
SIZE (mm)	x	144	175	225
HEIGHT (mm)	H	35	35	35
LUMEN OUTPUT	C 6500K	1620	2160	3240
	N 4000K	1620	2160	3240
	W 3000K	1620	2160	3240

### Features:

- Simple and convenient installation
- Soft light eye protection
- High illuminated light source
- High quality PC material

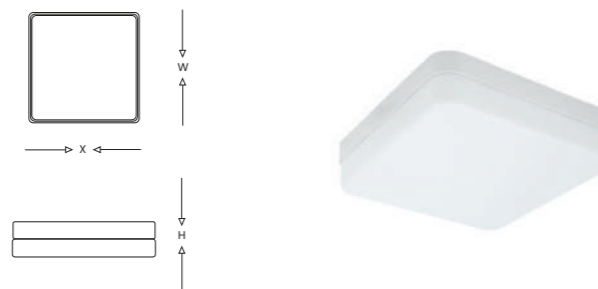

BODY COLOUR  White

CRI	INPUT
>80	AC 85-265V

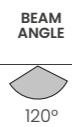

MATERIAL	POLY CARBONATE
CHIP	SANAN
POWER FACTOR/KV	>0.9/KV>2.5

	WATTAGE	18W	24W	36W
SIZE (mm)	L*W	144*144	175*175	225*225
HEIGHT (mm)	H	35	35	35
LUMEN OUTPUT	C 6500K	1620	2160	3240
	N 4000K	1620	2160	3240
	W 3000K	1620	2160	3240



# ALCAZAR

## SURFACE PANEL LIGHT

### Features:

- Narrow edge aluminum surface panel design
- High brightness
- High illuminated light source
- Engineering Aluminum material



BODY COLOUR  White

CRI	INPUT
>80	AC 100-265V

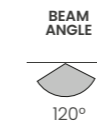

MATERIAL	ALUMINIUM
CHIP	SANAN
POWER FACTOR/KV	>0.9/KV>2.5

	WATTAGE	6W	8W	12W
SIZE (mm)	x	120	120	170
HEIGHT (mm)	H	25	25	25
LUMEN OUTPUT	C 6500K	480	640	960
	N 4000K	480	640	960
	W 3000K	480	640	960

### Features:

- Narrow edge aluminum surface panel design
- High brightness
- High illuminated light source
- Engineering Aluminum material



BODY COLOUR  White

CRI	INPUT
>80	AC 100-265V

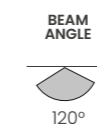

MATERIAL	ALUMINIUM
CHIP	SANAN
POWER FACTOR/KV	>0.9/KV>2.5

	WATTAGE	6W	8W	12W
SIZE (mm)	L*W	120*120	120*120	170*170
HEIGHT (mm)	H	25	25	25
LUMEN OUTPUT	C 6500K	480	640	960
	N 4000K	480	640	960
	W 3000K	480	640	960



# VENUS

## SURFACE PANEL LIGHT

### Features:

- Simple and elegant design
- High illuminated light source
- Engineering Aluminum and PC material
- Low maintenance and long life



BODY COLOUR  White

BEAM ANGLE



CRI	INPUT
>80	AC 100-265V

MATERIAL	ALUMINIUM
CHIP	SANAN
POWER FACTOR/KV	>0.9/kV>2.5

WATTAGE	6W			12W			18W			
	SIZE (mm)	x	86	115	175	HEIGHT (mm)	H	55	55	55
LUMEN OUTPUT	C 6500K	480	960	1440						
	N 4000K	480	960	1440						
	W 3000K	480	960	1440						

### Features:

- Simple and elegant design
- High illuminated light source
- Engineering Aluminum and PC material
- Low maintenance and long life

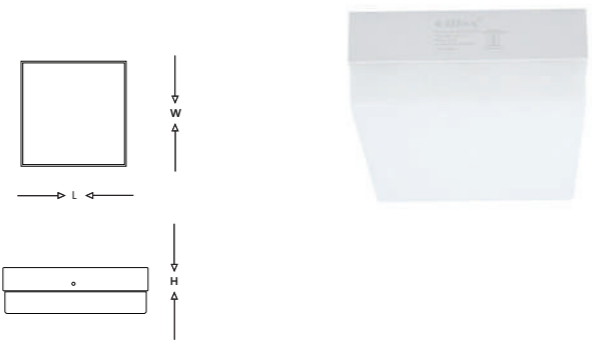

BODY COLOUR  White

BEAM ANGLE



CRI	INPUT
>80	AC 100-265V

MATERIAL	ALUMINIUM
CHIP	SANAN
POWER FACTOR/KV	>0.9/kV>2.5

WATTAGE	6W			12W			18W			
	SIZE (mm)	L*W	86*86	115*115	175*175	HEIGHT (mm)	H	55	55	55
LUMEN OUTPUT	C 6500K	480	960	1440						
	N 4000K	480	960	1440						
	W 3000K	480	960	1440						



# PRISMA SURFACE

## SURFACE PANEL LIGHT

### Features:

- Crafted from durable PC material
- Slim frame design
- Simple and convenient installation
- High illuminated light source



BODY COLOUR  WHITE

BEAM ANGLE



CRI	INPUT
>92	AC 100-265V

MATERIAL	POLYCARBONATE
CHIP	SANAN
POWER FACTOR/KV	>0.88/kV>2.5

WATTAGE	6W		9W		15W		22W					
	SIZE (mm)	x	116	116	166	220	HEIGHT (mm)	H	40	40	40	40
LUMEN OUTPUT	W 3000K	600	900	1500	2200							
	N 4000K	600	900	1500	2200							
	C 6500K	600	900	1500	2200							

### Features:

- Crafted from durable PC material
- Slim frame design
- Simple and convenient installation
- High illuminated light source



BODY COLOUR  WHITE

BEAM ANGLE



CRI	INPUT
>92	AC 100-265V

MATERIAL	POLYCARBONATE
CHIP	SANAN
POWER FACTOR/KV	>0.88/kV>2.5

WATTAGE	6W		9W		15W		22W					
	SIZE (mm)	L*W	116*116	116*116	166*166	220*220	HEIGHT (mm)	H	40	40	40	40
LUMEN OUTPUT	W 3000K	552	828	1380	2024							
	N 4000K	552	828	1380	2024							
	C 6500K	552	828	1380	2024							





## LED PENDENT LIGHT

### — Series —

- Adopts a simple and extremely spherical appearance and has two characteristics of key lighting and atmosphere lighting
- Simple cylindrical shape design made by aluminum show a natural and understated luxury appearance
- Multilevel reflect technology lens for excellent light performance under shorter lens height
- Suitable for home, business, club, and other places



# PENDENT



## SATURN

WATTAGE 3W  
 CCT W N C  
 CRI >90  
 INPUT VOLTAGE 220-240V AC  
 DIMENSION x\*H 64\*71mm  
 CHIP CREE  
 COLOUR BLACK+GOLD

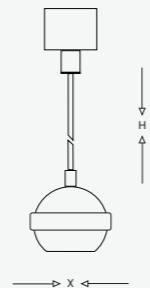

## KATYA

WATTAGE 5W  
 CCT W N C  
 CRI >90  
 INPUT VOLTAGE 220-240V AC  
 DIMENSION x\*H 65\*308mm  
 CHIP CREE  
 COLOUR BLACK+GOLD



## DIAMOND

WATTAGE 5W  
 CCT W N C  
 CRI >90  
 INPUT VOLTAGE 220-240V AC  
 DIMENSION x\*H 70\*195mm  
 CHIP CREE  
 COLOUR BLACK+GOLD

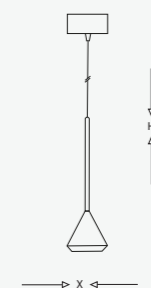



### DARIA

WATTAGE 8W  
 DIMENSION x\*H 60\*120mm  
 POWER SOURCE LED  
 INPUT VOLTAGE 100-265V  
 COLOUR BLUE+GOLD  
 MATERIAL ALUMINIUM

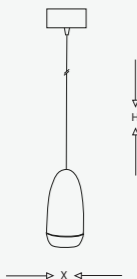

### IVAN

WATTAGE 8W  
 DIMENSION x\*H 80\*120mm  
 POWER SOURCE LED  
 INPUT VOLTAGE 100-265V  
 COLOUR SAND BLACK  
 MATERIAL ALUMINIUM



### SPOT

WATTAGE 8W  
 DIMENSION x\*H 100\*100mm  
 POWER SOURCE LED  
 INPUT VOLTAGE 100-265V  
 COLOUR BROWN  
 MATERIAL ALUMINIUM+ACRYLIC



### MARIA

WATTAGE 8W  
 DIMENSION x\*H 83\*230mm  
 POWER SOURCE LED  
 INPUT VOLTAGE 100-265V  
 COLOUR GOLD+PEARL BLACK  
 MATERIAL ALUMINIUM



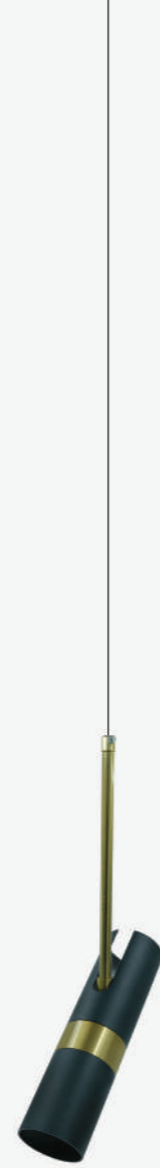

**WAFI**

WATTAGE 8W  
 DIMENSION x\*H 40\*230mm  
 POWER SOURCE LED  
 INPUT VOLTAGE 100-265V  
 COLOUR GREY+GOLD  
 MATERIAL ALUMINIUM



**ZAKI**

DIMENSION x\*H 60\*60mm  
 POWER SOURCE GU10  
 INPUT VOLTAGE 85-265V  
 COLOUR BLACK+GOLD  
 MATERIAL ALUMINIUM



**ROD**

WATTAGE 8W  
 DIMENSION x\*H 30\*450mm  
 POWER SOURCE LED  
 INPUT VOLTAGE 110-220V  
 COLOUR GOLD BRONZE+ BLACK  
 MATERIAL ALUMINIUM



**ZARA**

WATTAGE 9W  
 DIMENSION x\*H 68\*298mm  
 POWER SOURCE LED  
 INPUT VOLTAGE 110-220V  
 COLOUR MATT WHITE+GOLD  
 MATERIAL ALUMINIUM

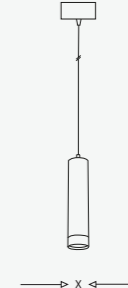



**LANA**

WATTAGE 7W  
 DIMENSION x\*H 58\*198mm  
 POWER SOURCE LED  
 INPUT VOLTAGE 110-220V  
 COLOUR BLACK+GOLD  
 MATERIAL ALUMINIUM

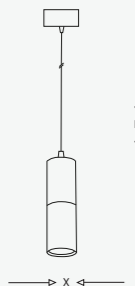

**LARA**

WATTAGE 12W  
 DIMENSION x\*H 50\*300mm  
 POWER SOURCE LED  
 INPUT VOLTAGE 110-220V  
 COLOUR MATT BLACK  
 MATERIAL ALUMINIUM+ACRYLIC

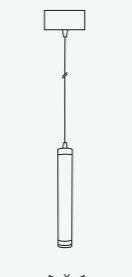

**GF-K907**

DIMENSION x\*H 150\*270mm  
 POWER SOURCE 1\*E27  
 INPUT VOLTAGE 85-265V  
 COLOUR BLACK+GREY  
 MATERIAL METAL+CEMENT





**IGF-A907**

DIMENSION 120\*260mm  
 POWER SOURCE 1\*E27  
 INPUT VOLTAGE 85-265V  
 COLOUR GREY  
 MATERIAL METAL+CEMENT

**IGF-C907**

DIMENSION 205\*160mm  
 POWER SOURCE 1\*E27  
 INPUT VOLTAGE 85-265V  
 COLOUR GREY  
 MATERIAL METAL+CEMENT

**IGF-B907**

DIMENSION 180\*190mm  
 POWER SOURCE 1\*E27  
 INPUT VOLTAGE 85-265V  
 COLOUR GREY  
 MATERIAL METAL+CEMENT



**IGF-E907**

DIMENSION 240\*180mm  
 POWER SOURCE 1\*E27  
 INPUT VOLTAGE 85-265V  
 COLOUR GREY  
 MATERIAL METAL+CEMENT

**IGF-D907**

DIMENSION 165\*255mm  
 POWER SOURCE 1\*E27  
 INPUT VOLTAGE 85-265V  
 COLOUR DARK GREY  
 MATERIAL METAL+CEMENT



**IGF-E908**

DIMENSION 300mm  
 POWER SOURCE 1\*E27  
 INPUT VOLTAGE 100-265V  
 COLOUR BLACK  
 MATERIAL POLYURETHANE

**IGF-F908**

DIMENSION 500mm  
 POWER SOURCE 1\*E27  
 INPUT VOLTAGE 100-265V  
 COLOUR BLACK  
 MATERIAL POLYURETHANE

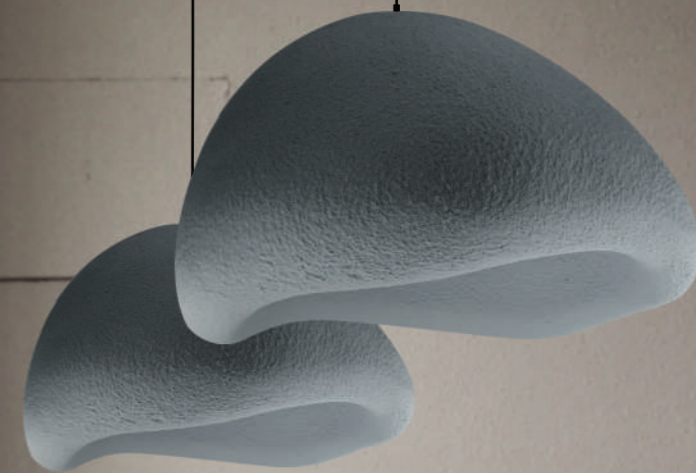

**IGF-A908**

DIMENSION 300mm  
 POWER SOURCE 1\*E27  
 INPUT VOLTAGE 100-265V  
 COLOUR GREY  
 MATERIAL POLYURETHANE

**IGF-B908**

DIMENSION 400mm  
 POWER SOURCE 1\*E27  
 INPUT VOLTAGE 100-265V  
 COLOUR GREY  
 MATERIAL POLYURETHANE

**IGF-C908**

DIMENSION 500mm  
 POWER SOURCE 1\*E27  
 INPUT VOLTAGE 100-265V  
 COLOUR GREY  
 MATERIAL POLYURETHANE



## LED CABINET LIGHT

### — Series —

- With minimal size and pure functionality, the LED cabinet light is a miniature led spotlight aimed at replacing the traditional lighting in the application of furniture and cabinets lighting
- Featuring a perfect balance between size and luminous flux, our cabinet light combines extremely precise accent light with high energy saving performance
- They can be used in furniture, cabinet, kitchen, washroom etc

### GD-45A



**WATTAGE** 3W  
**SIZE** 40mm  
**CUT OUT** 30mm  
**HEIGHT** 28mm  
**BODY COLOUR** BLACK  
**MATERIAL** ALUMINIUM  
**VOLTAGE** 100-265V  
**SHAPE** ROUND  
**CHIP** CREE  
**COLOUR OPTIONS**

### GD-45B



**WATTAGE** 3W  
**SIZE** 39mm  
**CUT OUT** 28mm  
**HEIGHT** 25mm  
**BODY COLOUR** BLACK  
**MATERIAL** ALUMINIUM  
**VOLTAGE** 100-265V  
**SHAPE** ROUND  
**CHIP** CREE  
**COLOUR OPTION**

### GE-31

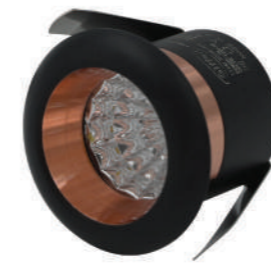

**WATTAGE** 1W  
**SIZE** 33mm  
**CUT OUT** 22mm  
**HEIGHT** 28mm  
**BODY COLOUR** BLACK + ROSEGOLD  
**MATERIAL** ALUMINIUM  
**VOLTAGE** 100-265V  
**SHAPE** ROUND  
**CHIP** BRIDGELUX-USA  
**COLOUR OPTION**

### GD-44



**WATTAGE** 3W  
**SIZE** 45mm  
**CUT OUT** 37mm  
**HEIGHT** 46mm  
**BODY COLOUR** WHITE, BLACK  
**MATERIAL** ALUMINIUM  
**VOLTAGE** 100-265V  
**SHAPE** ROUND  
**CHIP** BRIDGELUX-USA  
**COLOUR OPTION**

### GG-48



**WATTAGE** 3W  
**SIZE** 40mm  
**CUT OUT** 37mm  
**HEIGHT** 39mm  
**BODY COLOUR** WHITE + BLACK / GOLD  
**MATERIAL** ALUMINIUM  
**VOLTAGE** 100-265V  
**SHAPE** ROUND  
**CHIP** BRIDGELUX-USA  
**COLOUR OPTIONS**

### GZ-305



**WATTAGE** 3W  
**SIZE** 41mm  
**CUT OUT** 32mm  
**HEIGHT** 36mm  
**BODY COLOUR** WHITE  
**MATERIAL** ALUMINIUM  
**VOLTAGE** 100-265V  
**SHAPE** ROUND  
**CHIP** SANAN  
**COLOUR OPTIONS**





**GG-45**



WATTAGE 1W  
 SIZE 33mm  
 CUT OUT 25mm  
 HEIGHT 21mm  
 BODY COLOUR WHITE, BLACK, SILVER, COPPER  
 MATERIAL ALUMINIUM  
 VOLTAGE 100-265V  
 SHAPE ROUND  
 CHIP BRIDGELUX-USA  
 COLOUR OPTION **N W**

**GG-46**



WATTAGE 1W  
 SIZE 53mm  
 CUT OUT 43mm  
 HEIGHT 18mm  
 BODY COLOUR WHITE, BLACK  
 MATERIAL ALUMINIUM  
 VOLTAGE 100-265V  
 SHAPE ROUND  
 CHIP BRIDGELUX-USA  
 COLOUR OPTION **N W**



**GG-47**

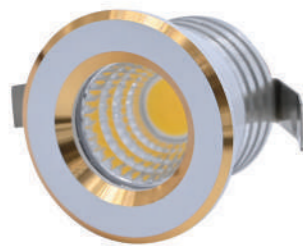

WATTAGE 3W  
 SIZE 32mm  
 CUT OUT 29mm  
 HEIGHT 32mm  
 BODY COLOUR GOLD + WHITE/BLACK  
 MATERIAL ALUMINIUM  
 VOLTAGE 100-265V  
 SHAPE ROUND  
 CHIP BRIDGELUX-USA  
 COLOUR OPTION **N W**

**GG-49**



WATTAGE 3W  
 SIZE 32mm  
 CUT OUT 29mm  
 HEIGHT 32mm  
 BODY COLOUR WHITE, SILVER, BLACK  
 MATERIAL ALUMINIUM  
 VOLTAGE 100-265V  
 SHAPE ROUND  
 CHIP BRIDGELUX-USA  
 COLOUR OPTION **N W**

**GG-43**



WATTAGE 3W  
 SIZE 46\*46mm  
 CUT OUT 34mm  
 HEIGHT 25mm  
 BODY COLOUR WOOD  
 MATERIAL ALUMINIUM  
 VOLTAGE 100-265V  
 SHAPE SQUARE  
 CHIP BRIDGELUX-USA  
 COLOUR OPTION **N W**

**GG-43B**



WATTAGE 3W  
 SIZE 48mm  
 CUT OUT 34mm  
 HEIGHT 25mm  
 BODY COLOUR WOOD, COPPER, BLACK  
 MATERIAL ALUMINIUM  
 VOLTAGE 100-265V  
 SHAPE ROUND  
 CHIP BRIDGELUX-USA  
 COLOUR OPTION **N W**

**GG-51**



WATTAGE 1W  
 SIZE 29mm  
 CUT OUT 22mm  
 HEIGHT 31mm  
 BODY COLOUR WHITE, BLACK, SILVER, GOLD  
 MATERIAL ALUMINIUM  
 VOLTAGE 100-265V  
 SHAPE ROUND  
 CHIP BRIDGELUX-USA  
 COLOUR OPTIONS 

**GG-52**



WATTAGE 1W  
 SIZE 37mm  
 CUT OUT 34mm  
 HEIGHT 34mm  
 BODY COLOUR SILVER, BLACK  
 MATERIAL ALUMINIUM  
 VOLTAGE 100-265V  
 SHAPE ROUND  
 CHIP BRIDGELUX-USA  
 COLOUR OPTIONS 

**GC-27**



WATTAGE 1W  
 SIZE 31mm  
 CUT OUT 24mm  
 HEIGHT 21mm  
 BODY COLOUR WHITE  
 MATERIAL ALUMINIUM  
 VOLTAGE 100-265V  
 SHAPE ROUND  
 CHIP SANAN  
 COLOUR OPTIONS 

**GC-33**



WATTAGE 1W  
 SIZE 31mm\*31mm  
 CUT OUT 20mm  
 HEIGHT 21mm  
 BODY COLOUR WHITE  
 MATERIAL ALUMINIUM  
 VOLTAGE 100-265V  
 SHAPE SQUARE  
 CHIP SANAN  
 COLOUR OPTIONS 

**GE-15**



WATTAGE 3W  
 SIZE 40mm  
 CUT OUT 28mm  
 HEIGHT 29mm  
 BODY COLOUR WHITE  
 MATERIAL ALUMINIUM  
 VOLTAGE 100-265V  
 SHAPE ROUND  
 CHIP BRIDGELUX-USA  
 COLOUR OPTIONS 

**GE-16**



WATTAGE 3W  
 SIZE 40\*40mm  
 CUT OUT 28mm  
 HEIGHT 29mm  
 BODY COLOUR WHITE  
 MATERIAL ALUMINIUM  
 VOLTAGE 100-265V  
 SHAPE SQUARE  
 CHIP BRIDGELUX-USA  
 COLOUR OPTIONS 



### GG-01

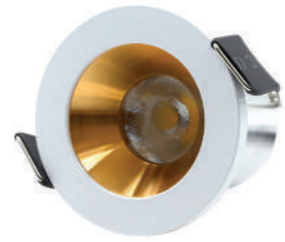

WATTAGE 3W  
 SIZE 45mm  
 CUT OUT 36mm  
 HEIGHT 38mm  
 BODY COLOUR WHITE+GOLD  
 MATERIAL ALUMINIUM  
 VOLTAGE 100-265V  
 SHAPE ROUND  
 CHIP BRIDGELUX-USA  
 COLOUR OPTIONS

### GG-02



WATTAGE 3W  
 SIZE 45\*45mm  
 CUT OUT 36mm  
 HEIGHT 38mm  
 BODY COLOUR WHITE+GOLD  
 MATERIAL ALUMINIUM  
 VOLTAGE 100-265V  
 SHAPE SQUARE  
 CHIP BRIDGELUX-USA  
 COLOUR OPTIONS



### GC-64



WATTAGE 3W  
 SIZE 44mm  
 CUT OUT 36mm  
 HEIGHT 22mm  
 BODY COLOUR WHITE  
 MATERIAL ALUMINIUM  
 VOLTAGE 100-265V  
 SHAPE ROUND  
 CHIP SANAN  
 COLOUR OPTIONS

### GC-65



WATTAGE 3W  
 SIZE 44\*44mm  
 CUT OUT 36\*36mm  
 HEIGHT 22mm  
 BODY COLOUR WHITE  
 MATERIAL ALUMINIUM  
 VOLTAGE 100-265V  
 SHAPE SQUARE  
 CHIP SANAN  
 COLOUR OPTIONS

### GC-39



WATTAGE 1W  
 SIZE 31mm  
 CUT OUT 24mm  
 HEIGHT 21mm  
 BODY COLOUR WHITE  
 MATERIAL ALUMINIUM  
 VOLTAGE 100-265V  
 SHAPE ROUND  
 CHIP SANAN  
 COLOUR OPTIONS

### GC-45



WATTAGE 1W  
 SIZE 31\*31mm  
 CUT OUT 24mm  
 HEIGHT 21mm  
 BODY COLOUR WHITE  
 MATERIAL ALUMINIUM  
 VOLTAGE 100-265V  
 SHAPE SQUARE  
 CHIP SANAN  
 COLOUR OPTIONS



### MAGNA

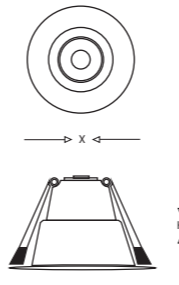

WATTAGE	3W
SIZE (mm) x	70
CUTOUT (mm)	38,5
HEIGHT (mm) H	33
MATERIAL	POLY CARBONATE
CHIP	SANAN
POWER FACTOR/KV	>0.6/KV>1.5

CRI	INPUT	LUMENS
RA>80	AC 85-285V	240LM

COLOUR OPTIONS: C N W

BEAM ANGLE: 120°

COLOUR OPTIONS: White



### DEITO



WATTAGE	3W
SIZE (mm) x	70
CUTOUT (mm)	47
HEIGHT (mm) H	26
MATERIAL	POLY CARBONATE
CHIP	SANAN
POWER FACTOR/KV	>0.6/KV>1.5

CRI	INPUT	LUMENS
RA>80	AC 85-285V	240LM

COLOUR OPTIONS: C N W R G B P

BEAM ANGLE: 120°

COLOUR OPTIONS: White

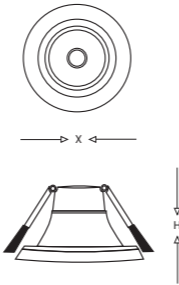

### CLASSIC



WATTAGE	3W
SIZE (mm) x	72
CUTOUT (mm)	52
HEIGHT (mm) H	26
MATERIAL	POLY CARBONATE
CHIP	SANAN
POWER FACTOR/KV	>0.6/KV>1.5

CRI	INPUT	LUMENS
RA>80	AC 85-285V	240LM

COLOUR OPTIONS: C N W

BEAM ANGLE: 120°

COLOUR OPTIONS: White

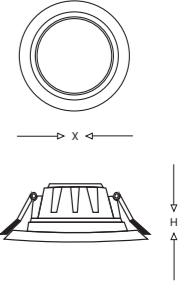



## LED STRIP LIGHT

### Series

- LED neon flex offers designers and architects the essential tools to create exquisite lighting installations
- High luminance efficiency, small light wave, and long service life.
- High brightness SMD, energy conservation and environment protection
- Widely used in shops, Hotels, decorative stair outline, park landscaping and LED lighting engineering

## FURINO-60

LED TYPE	SMD 5050
LED QTY	60LEDS/MTR
LED CHIP &LED BRAND	SANAN
INPUT VOLTAGE	12V DC
CRI	80
PCB	10mm WIDTH
BEAM ANGLE	120°
COLOUR	W N C B P
IP RATING	IP20
POWER	10-12 W



## FURINO-120

LED TYPE	SMD 2835
LED QTY	120LEDS/MTR
LED CHIP &LED BRAND	SANAN
INPUT VOLTAGE	12V DC
CRI	80
PCB	8mm WIDTH
BEAM ANGLE	120°
COLOUR	W N C I R B G
IP RATING	IP20
POWER	10W/MTR



## FURINO-180

LED TYPE	SMD 2835
LED QTY	180LED/MTR
LED CHIP &LED BRAND	SANAN
INPUT VOLTAGE	12V DC
CRI	80
PCB	5mm WIDTH
BEAM ANGLE	120°
CCT	W N C
IP RATING	IP20
POWER	14-16 W



## FURINO-240

LED TYPE	SMD 2835
LED QTY	240LEDS/MTR
LED CHIP &LED BRAND	SANAN
INPUT VOLTAGE	12V DC
CRI	80
PCB	10mm WIDTH
BEAM ANGLE	120°
COLOUR	W N C
IP RATING	IP20
POWER	18-20W





Features:

- Double-sided PCB assure excellent heat dissipation.
- Available in homogeneous white tones, start from 2700K till 6500K.
- Longer connection length per input of up to 50m/164'
- Premium light quality, offer CRI up to Ra80+
- IP65 rated and for damp or wet location use.
- Easy installation due to optional solder-free connector.
- Reliable AC-DC rectifier and flicker-free driver optional.

## NEO FLEX IP 65

LED TYPE	SMD 2835
LED QTY	180LED/MTR
LED CHIP & LED BRAND	SANAN
INPUT VOLTAGE	220V
CRI	80
PCB	12mm WIDTH
BEAM ANGLE	120°
CCT	W N C
IP RATING	IP65
POWER	8W/MTR



## POWER SUPPLY

PRODUCT CODE	CURRENT	WATTAGE	VDC	DIMENSION	IP RATING	INPUT VOLTAGE
GD-35A	3A	36W	12V	103*30*21	IP20	100-265V
GD-35C	5A	60W	12V	160*40*32	IP20	100-265V
GD-35C1	8.3A	100W	12V	188*46*35	IP20	100-265V
GD-35D	10A	120W	12V	138*49.5*22	IP20	100-265V
GD-35E	12.5A	150W	12V	178*49.5*22	IP20	100-265V
GD-35G	16.5A	200W	12V	178*49.5*22	IP20	100-265V
GD-35H	20.8A	250W	12V	205*49.5*22	IP20	100-265V
GD-35J	25A	300W	12V	205*49.5*22	IP20	100-265V



## LED STEP LIGHT

### — Series —

- This is an excellent design for auxiliary lighting at the foot of the wall.
- The light outlet of different shapes corresponds to its unique light form, which is very individual
- Minimalist strip design combined with special light effect, brings a good sense of advancement





# GF A691

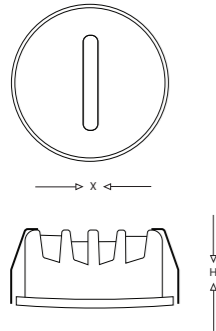

WATTAGE	3W
SIZE (mm) x*H	45*27
CUT OUT (mm)	35

CRI	INPUT	BODY COLOUR
>90	AC 110-240V	SAND BLACK W 3000K

MATERIAL	ALUMINIUM
CHIP	CREE



# GF A692

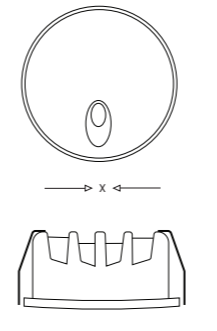

WATTAGE	3W
SIZE (mm) x*H	45*27
CUT OUT (mm)	35

CRI	INPUT	BODY COLOUR
>90	AC 220-240V	SAND BLACK W 3000K

MATERIAL	ALUMINIUM
CHIP	CREE

# GF A684

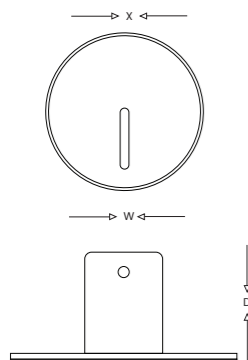

WATTAGE	3W
SIZE (mm) x*w*D	89*40*54
CUT OUT (mm)	75*40

CRI	INPUT	BODY COLOUR
>90	AC 110-240V	SAND BLACK W 3000K

MATERIAL	ALUMINIUM
CHIP	CREE

# GF A693

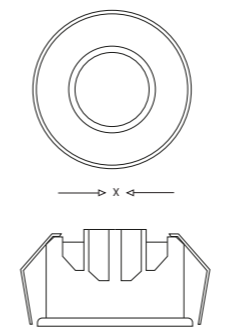

WATTAGE	3W
SIZE (mm) x*H	46*28
CUT OUT (mm)	35

CRI	INPUT	BODY COLOUR
>90	AC 220-240V	SAND BLACK W 3000K

MATERIAL	ALUMINIUM
CHIP	CREE

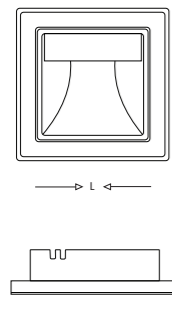

### GZ 437

WATTAGE  
 SIZE (mm) L\*W\*H  
 MODULE  
 CCT  
 MATERIAL  
 VOLTAGE  
 CHIP  
 BODY COLOUR

1.5  
 100\*100\*40  
 2MD  
 3000,4000K  
 FIBER  
 100-260V  
 SMD  
 ● ○ ● ●

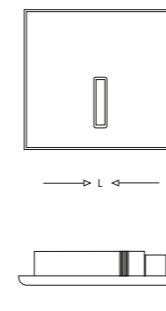

### GZ 456

WATTAGE  
 SIZE (mm) L\*W\*H  
 MODULE  
 CCT  
 MATERIAL  
 VOLTAGE  
 CHIP  
 BODY COLOUR

1.5  
 100\*100\*40  
 2MD  
 3000,4000K  
 FIBER  
 100-260V  
 SMD  
 ● ● ● ●

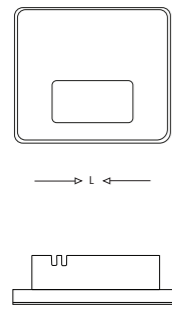

### GZ 450

WATTAGE  
 SIZE (mm) L\*W\*H  
 MODULE  
 CCT  
 MATERIAL  
 VOLTAGE  
 CHIP  
 BODY COLOUR

1.5  
 100\*100\*40  
 2MD  
 3000,4000K  
 FIBER  
 100-260V  
 SMD  
 ●

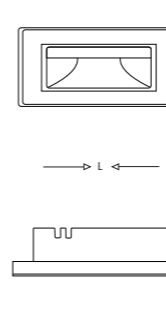

### GZ 445

WATTAGE  
 SIZE (mm) L\*W\*H  
 MODULE  
 CCT  
 MATERIAL  
 VOLTAGE  
 CHIP  
 BODY COLOUR

1.5  
 124\*37\*80  
 3MD  
 3000,4000K  
 FIBER  
 100-260V  
 SMD  
 ○ ● ● ●

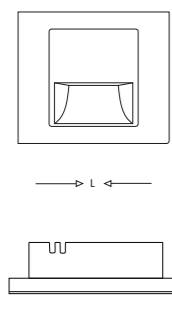

### GZ 451

WATTAGE  
 SIZE (mm) L\*W\*H  
 MODULE  
 CCT  
 MATERIAL  
 VOLTAGE  
 CHIP  
 BODY COLOUR

1.5  
 100\*100\*40  
 2MD  
 3000,4000K  
 FIBER  
 100-260V  
 SMD  
 ● ● ● ●

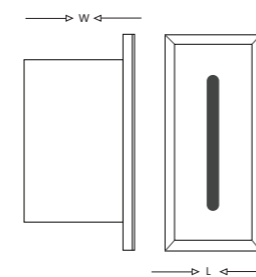

### GF A723

WATTAGE  
 SIZE (mm) L\*W\*H  
 CUTOFF  
 CCT  
 MATERIAL  
 VOLTAGE  
 CHIP  
 BODY COLOUR

3  
 88\*38\*56  
 75\*35\*52  
 3000K  
 ALUMINIUM + PC  
 100-260V  
 SANAN  
 ○





## OUTDOOR LIGHTS

---

- LED WALL LIGHTS
- LED BOLLARD
- LED BULKHEAD
- LED BRICK LIGHT
- LED SPIKE LIGHT
- LED INGROUND LIGHT
- LED FLOOD LIGHT
- LED UFO HIGH BAY LIGHT
- PENDANT LIGHT
- GARDEN LIGHT

LED WALL LIGHT



**GX 1754**

WATTAGE	12W
SIZE (mm) x $\phi$	220*50
MATERIAL	DIECAST ALUMINIUM
VOLTAGE	85-265V
CCT	3000K
CHIP	BRIDGELUX-USA
BODY COLOUR	STONE GREY
IP RATING	IP65

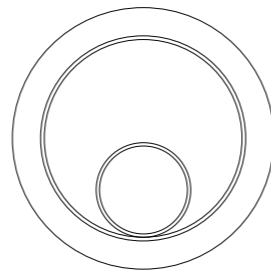

LED WALL LIGHT



**GX 1757**

WATTAGE	2*5W
SIZE (mm) w $\times$ d $\times$ h	105*50*180
MATERIAL	DIECAST ALUMINIUM
VOLTAGE	85-265V
CCT	3000K
CHIP	BRIDGELUX-USA
BODY COLOUR	STONE GREY
IP RATING	IP65

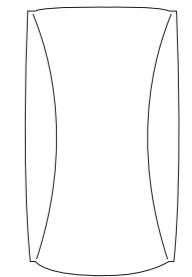



**GX 1755**

WATTAGE	16W
SIZE (mm)	220*220*70
MATERIAL	DIECAST ALUMINIUM
VOLTAGE	85-265V
CCT	3000K
CHIP	BRIDGELUX-USA
BODY COLOUR	STONE GREY
IP RATING	IP65

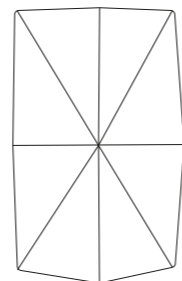

**GG 86**

WATTAGE	2*5W
SIZE (mm) w $\times$ d $\times$ h	105*50*180
MATERIAL	DIECAST ALUMINIUM
VOLTAGE	85-265V
CCT	3000K
CHIP	BRIDGELUX-USA
BODY COLOUR	STONE GREY
IP RATING	IP65



LED WALL LIGHT



**IGX 1760**

WATTAGE	2*7W
SIZE (mm)	130*48*235
MATERIAL	DIECAST ALUMINIUM
VOLTAGE	85-265V
CCT	3000K
CHIP	BRIDGELUX-USA
BODY COLOUR	STONE GREY
IP RATING	IP65

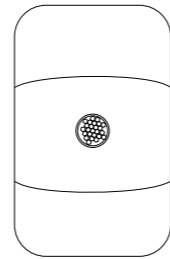

LED WALL LIGHT



**IGZ 695**

WATTAGE	2*6W
SIZE (mm)	265*66*160
MATERIAL	DIECAST ALUMINIUM
VOLTAGE	85-265V
CCT	3000K
CHIP	BRIDGELUX-USA
BODY COLOUR	STONE GREY
IP RATING	IP65

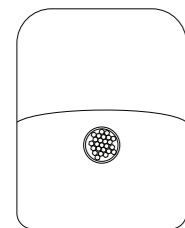
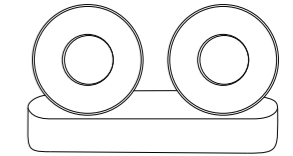

**IGX 1764**

WATTAGE	7W
SIZE (mm)	130*48*163
MATERIAL	DIECAST ALUMINIUM
VOLTAGE	85-265V
CCT	3000K
CHIP	BRIDGELUX-USA
BODY COLOUR	STONE GREY
IP RATING	IP65

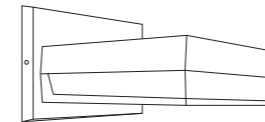
**IGZ 692**

WATTAGE	6W
SIZE (mm)	120*120*160
MATERIAL	DIECAST ALUMINIUM
VOLTAGE	85-265V
CCT	3000K
CHIP	BRIDGELUX-USA
BODY COLOUR	STONE GREY
IP RATING	IP65



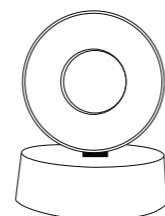

**IGZ 694**

WATTAGE	6W
SIZE (mm)	120*120*160
MATERIAL	DIECAST ALUMINIUM
VOLTAGE	85-265V
CCT	3000K
CHIP	BRIDGELUX-USA
BODY COLOUR	STONE GREY
IP RATING	IP65

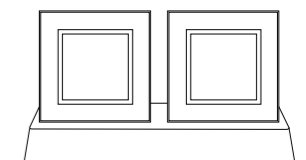

**IGZ 693**

WATTAGE	2*6W
SIZE (mm)	265*66*160
MATERIAL	DIECAST ALUMINIUM
VOLTAGE	85-265V
CCT	3000K
CHIP	BRIDGELUX-USA
BODY COLOUR	STONE GREY
IP RATING	IP65



LED WALL LIGHT



**GZ 689**

WATTAGE	7+5W
SIZE (mm)	120*120*130
MATERIAL	DIECAST ALUMINIUM
VOLTAGE	85-265V
CCT	3000K
CHIP	BRIDGELUX-USA
BODY COLOUR	STONE GREY
IP RATING	IP65

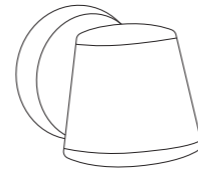

LED WALL LIGHT



**GZ 688**

WATTAGE	2*6W
SIZE (mm)	125*75*267
MATERIAL	DIECAST ALUMINIUM
VOLTAGE	85-265V
CCT	3000K
CHIP	BRIDGELUX-USA
BODY COLOUR	STONE GREY

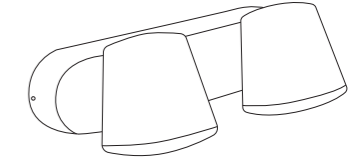



**GZ 690**

WATTAGE	2*12W
SIZE (mm)	125*85*267
MATERIAL	DIECAST ALUMINIUM
VOLTAGE	85-265V
CCT	3000K
CHIP	BRIDGELUX-USA
BODY COLOUR	STONE GREY
IP RATING	IP65

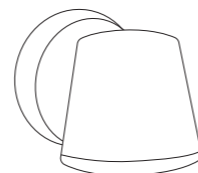

**GZ 687**

WATTAGE	6W
SIZE (mm)	120*120*130
MATERIAL	DIECAST ALUMINIUM
VOLTAGE	85-265V
CCT	3000K
CHIP	BRIDGELUX-USA
BODY COLOUR	STONE GREY
IP RATING	IP65



LED WALL LIGHT



**GZ 681**

WATTAGE	7+5W
SIZE (mm)	105*85*125
MATERIAL	DIECAST ALUMINIUM
VOLTAGE	85-265V
CCT	3000K
CHIP	BRIDGELUX-USA
BODY COLOUR	STONE GREY
IP RATING	IP65

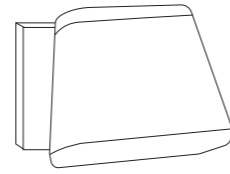

LED WALL LIGHT



**GZ 684**

WATTAGE	2*6W
SIZE (mm)	105*80*267
MATERIAL	DIECAST ALUMINIUM
VOLTAGE	85-265V
CCT	3000K
CHIP	BRIDGELUX-USA
BODY COLOUR	STONE GREY
IP RATING	IP65

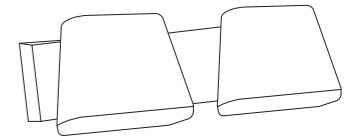

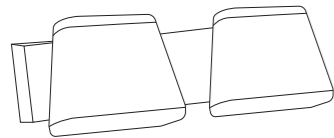

**GZ 682**

WATTAGE	2*12W
SIZE (mm)	105*105*267
MATERIAL	DIECAST ALUMINIUM
VOLTAGE	85-265V
CCT	3000K
CHIP	BRIDGELUX-USA
BODY COLOUR	STONE GREY
IP RATING	IP65



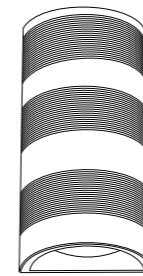
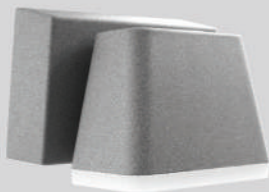

**GZ 702**

WATTAGE	2*5W
SIZE (mm)	90*55*160
MATERIAL	DIECAST ALUMINIUM
VOLTAGE	85-265V
CCT	3000K
CHIP	BRIDGELUX-USA
BODY COLOUR	STONE GREY
IP RATING	IP65

**GZ 683**

WATTAGE	6W
SIZE (mm)	124*85*160
MATERIAL	DIECAST ALUMINIUM
VOLTAGE	85-265V
CCT	3000K
CHIP	BRIDGELUX-USA
BODY COLOUR	STONE GREY
IP RATING	IP65

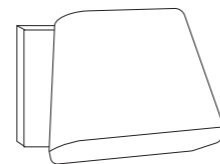

**GG 70B**

WATTAGE	2*3W
SIZE (mm)	75*80*237
MATERIAL	DIECAST ALUMINIUM
VOLTAGE	85-265V
CCT	3000K
CHIP	BRIDGELUX-USA
BODY COLOUR	STONE GREY
IP RATING	IP65



LED WALL LIGHT



**GX1785**

WATTAGE	12W
SIZE (mm)	150*160*180
MATERIAL	DIECAST ALUMINIUM
VOLTAGE	85-265V
CCT	3000K
CHIP	BRIDGELUX-USA
BODY COLOUR	STONE GREY
IP RATING	IP65

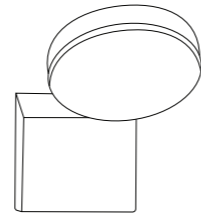

LED WALL LIGHT



**GX1791**

WATTAGE	12W
SIZE (mm)	291*140*80
MATERIAL	DIECAST ALUMINIUM
VOLTAGE	85-265V
CCT	3000K
CHIP	BRIDGELUX-USA
BODY COLOUR	STONE GREY
IP RATING	IP65



**GX1787**

WATTAGE	7W
SIZE (mm)	160*160*45
MATERIAL	DIECAST ALUMINIUM
VOLTAGE	85-265V
CCT	3000K
CHIP	BRIDGELUX-USA
BODY COLOUR	STONE GREY
IP RATING	IP65



**GX1788**

WATTAGE	7W
SIZE (mm)	156*156*45
MATERIAL	DIECAST ALUMINIUM
VOLTAGE	85-265V
CCT	3000K
CHIP	BRIDGELUX-USA
BODY COLOUR	STONE GREY
IP RATING	IP65





LED WALL LIGHT



**IGZ 698**

WATTAGE	2*3W
SIZE (mm)	150*65*30
MATERIAL	DIECAST ALUMINIUM
VOLTAGE	85-265V
CCT	3000K
CHIP	BRIDGELUX-USA
BODY COLOUR	STONE GREY
IP RATING	IP65



LED WALL LIGHT



**IGX 1759**

WATTAGE	2*6W
SIZE (mm)	240*45*120
MATERIAL	DIECAST ALUMINIUM
VOLTAGE	85-265V
CCT	3000K
CHIP	BRIDGELUX-USA
BODY COLOUR	STONE GREY
IP RATING	IP65

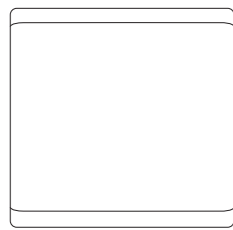
**IGZ 699**

WATTAGE	2*3W
SIZE (mm)	115*75*30
MATERIAL	DIECAST ALUMINIUM
VOLTAGE	85-265V
CCT	3000K
CHIP	BRIDGELUX-USA
BODY COLOUR	STONE GREY
IP RATING	IP65

**IGZ 701**

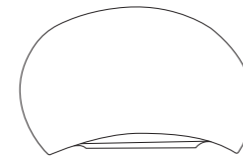
WATTAGE	2*5W
SIZE (mm)	180*60*115
MATERIAL	DIECAST ALUMINIUM
VOLTAGE	85-265V
CCT	3000K
CHIP	BRIDGELUX-USA
BODY COLOUR	STONE GREY
IP RATING	IP65



**IGG 73A**

WATTAGE	12W
SIZE (mm)	220*168*50
MATERIAL	DIECAST ALUMINIUM
VOLTAGE	85-265V
CCT	3000K
CHIP	BRIDGLUX-USA
BODY COLOUR	STONE GREY
IP RATING	IP65



**IGZ 700**

WATTAGE	2*5W
SIZE (mm)	105*55*190
MATERIAL	DIECAST ALUMINIUM
VOLTAGE	85-265V
CCT	3000K
CHIP	BRIDGLUX-USA
BODY COLOUR	STONE GREY
IP RATING	IP65



LED WALL LIGHT



**IG 70A**

WATTAGE	3*3W
SIZE (mm)	220*50*170
MATERIAL	DIECAST ALUMINIUM
VOLTAGE	85-265V
CCT	3000K
CHIP	BRIDGELUX-USA
BODY COLOUR	STONE GREY
IP RATING	IP65



LED WALL LIGHT



**IGX 281**

WATTAGE	12W
SIZE (mm)	150*230
MATERIAL	DIECAST ALUMINIUM
VOLTAGE	85-265V
CCT	3000K
CHIP	BRIDGELUX-USA
BODY COLOUR	STONE GREY
IP RATING	IP65

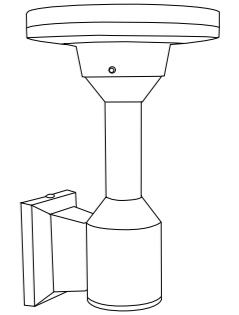



**IGX 1790**

WATTAGE	7W
SIZE (mm)	104*104*90
MATERIAL	DIECAST ALUMINIUM
VOLTAGE	85-265V
CCT	3000K
CHIP	BRIDGELUX-USA
BODY COLOUR	STONE GREY
IP RATING	IP65

**IGZ 503**

WATTAGE	12W
SIZE (mm)	170*115
MATERIAL	DIECAST ALUMINIUM
VOLTAGE	85-265V
CCT	3000K
CHIP	BRIDGLUX-USA
BODY COLOUR	STONE GREY
IP RATING	IP65

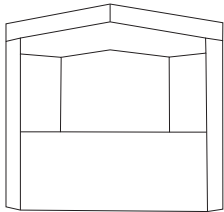

LED WALL LIGHT



**IGG 84A**

WATTAGE	7W
SIZE (mm)	140*140*55
MATERIAL	DIECAST ALUMINIUM
VOLTAGE	85-265V
CCT	3000K
CHIP	BRIDGELUX-USA
BODY COLOUR	STONE GREY
IP RATING	IP65



LED WALL LIGHT



**IGZ 500**

WATTAGE	5W
SIZE (mm)	106*106
MATERIAL	DIECAST ALUMINIUM
VOLTAGE	85-265V
CCT	3000K
CHIP	BRIDGELUX-USA
BODY COLOUR	STONE GREY
IP RATING	IP65

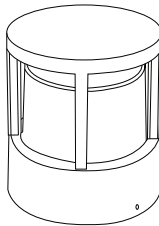

**IGG 84B**

WATTAGE	7W
SIZE (mm)	140*65*200
MATERIAL	DIECAST ALUMINIUM
VOLTAGE	85-265V
CCT	3000K
CHIP	BRIDGELUX-USA
BODY COLOUR	STONE GREY
IP RATING	IP65



**IGZ 501**

WATTAGE	5W
SIZE (mm)	108*108*103
MATERIAL	DIECAST ALUMINIUM
VOLTAGE	85-265V
CCT	3000K
CHIP	BRIDGELUX-USA
BODY COLOUR	STONE GREY
IP RATING	IP65



**IGZ 499**

WATTAGE	5W
SIZE (mm)	108*108*108
MATERIAL	DIECAST ALUMINIUM
VOLTAGE	85-265V
CCT	3000K
CHIP	BRIDGLUX-USA
BODY COLOUR	STONE GREY
IP RATING	IP65



**IGZ 502**

WATTAGE	5W
SIZE (mm)	106*106
MATERIAL	DIECAST ALUMINIUM
VOLTAGE	85-265V
CCT	3000K
CHIP	BRIDGLUX-USA
BODY COLOUR	STONE GREY
IP RATING	IP65



LED WALL LIGHT



**GX 263**

WATTAGE	5W
SIZE (mm)	134*105*115
MATERIAL	DIECAST ALUMINIUM
VOLTAGE	85-265V
CCT	3000K
CHIP	BRIDGELUX-USA
BODY COLOUR	STONE GREY
IP RATING	IP65



LED WALL LIGHT



**GX 256**

WATTAGE	2*5W
SIZE (mm)	153*100*50
MATERIAL	DIECAST ALUMINIUM
VOLTAGE	85-265V
CCT	3000K
CHIP	BRIDGELUX-USA
BODY COLOUR	STONE GREY
IP RATING	IP65



**GX 261**

WATTAGE	2*5W
SIZE (mm)	135*105*145
MATERIAL	DIECAST ALUMINIUM
VOLTAGE	85-265V
CCT	3000K
CHIP	BRIDGELUX-USA
BODY COLOUR	STONE GREY
IP RATING	IP65



**GX 258**

WATTAGE	2*5W
SIZE (mm)	180*90*105
MATERIAL	DIECAST ALUMINIUM
VOLTAGE	85-265V
CCT	3000K
CHIP	BRIDGELUX-USA
BODY COLOUR	STONE GREY
IP RATING	IP65







### LED WALL LIGHT

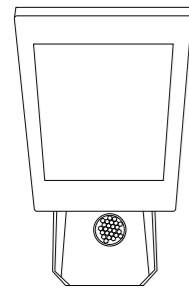
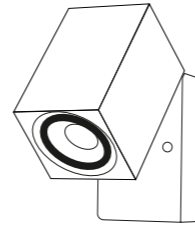

#### GX 280

WATTAGE 5W  
 SIZE (mm) 65\*94\*98  
 MATERIAL DIECAST ALUMINIUM  
 VOLTAGE 85-265V  
 CCT 3000K  
 CHIP BRIDGELUX-USA  
 BODY COLOUR STONE GREY  
 IP RATING IP65



#### GX 1767

WATTAGE 18W  
 SIZE (mm) 120\*85\*200  
 MATERIAL DIECAST ALUMINIUM  
 VOLTAGE 85-265V  
 CCT 3000K  
 CHIP BRIDGELUX-USA  
 BODY COLOUR STONE GREY  
 IP RATING IP65

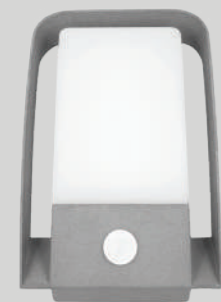

#### GX 1768

WATTAGE 15W  
 SIZE (mm) 260\*165\*40  
 MATERIAL DIECAST ALUMINIUM  
 VOLTAGE 85-265V  
 CCT 3000K  
 CHIP BRIDGLUX-USA  
 BODY COLOUR STONE GREY  
 IP RATING IP65

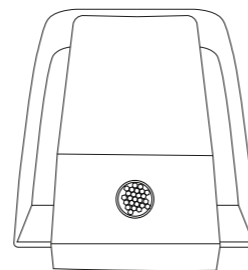

LED WALL LIGHT



**IGF 125E**

WATTAGE	4*3W
SIZE (mm)	120*120*42
MATERIAL	DIECAST ALUMINIUM
VOLTAGE	85-265V
CCT	3000K
CHIP	CREE
BODY COLOUR	SAND DARK GREY
IP RATING	IP 65

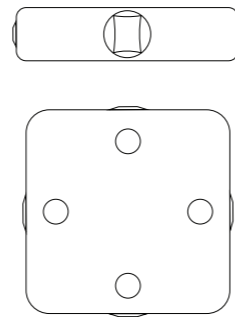

LED WALL LIGHT



**IGF 125I**

WATTAGE	2*1W
SIZE (mm)	85*85*57
MATERIAL	DIECAST ALUMINIUM
VOLTAGE	85-265V
CCT	3000K
CHIP	BRIDGLUX-USA
BODY COLOUR	SAND DARK GREY/ SAND BLACK
IP RATING	IP 65

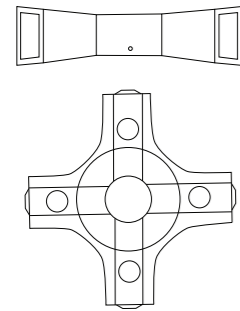
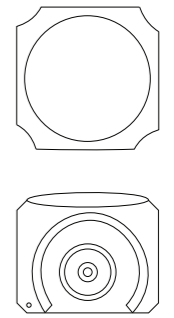

**IGF 125F**

WATTAGE	4*3W
SIZE (mm)	135*135*42
MATERIAL	DIECAST ALUMINIUM
VOLTAGE	85-265V
CCT	3000K
CHIP	CREE
BODY COLOUR	SAND DARK GREY
IP RATING	IP 65



**IGF 125G**

WATTAGE	4*1W
SIZE (mm)	85*85*57
MATERIAL	DIECAST ALUMINIUM
VOLTAGE	85-265V
CCT	3000K
CHIP	BRIDGLUX-USA
BODY COLOUR	SAND DARK GREY/ SAND BLACK
IP RATING	IP 65

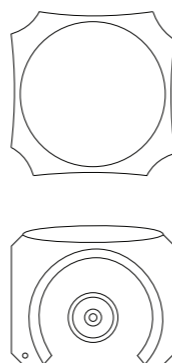



**IGF 125K**

WATTAGE	12W
SIZE (mm)	120*245*80
MATERIAL	DIECAST ALUMINIUM
VOLTAGE	85-265V
CCT	3000K
CHIP	SANAN
BODY COLOUR	SAND DARK GREY
IP RATING	IP 65



**IGF 125R**

WATTAGE	2*3+2*1W
SIZE (mm)	40*188*67.5
MATERIAL	DIECAST ALUMINIUM+PC
VOLTAGE	85-265V
CCT	3000K
CHIP	CREE+SANAN
BODY COLOUR	SAND DARK GREY
IP RATING	IP 65



**IGF 125N**

WATTAGE	2*3W
SIZE (mm)	205*115*45
MATERIAL	DIECAST ALUMINIUM
VOLTAGE	85-265V
CCT	3000K
CHIP	SANAN
BODY COLOUR	SAND DARK GREY
IP RATING	IP 65



**IGF 125S**

WATTAGE	2*1W
SIZE (mm)	100+100+65
MATERIAL	DIECAST ALUMINIUM
VOLTAGE	85-265V
CCT	3000K
CHIP	CREE
BODY COLOUR	SAND DARK GREY
IP RATING	IP 65



**IGF 125Q**

WATTAGE	2*1+2*1W
SIZE (mm)	100*100*65
MATERIAL	DIECAST ALUMINIUM
VOLTAGE	85-265V
CCT	3000K
CHIP	CREE+SANAN
BODY COLOUR	SAND DARK GREY
IP RATING	IP 65



**IGF 126**

WATTAGE	12W
SIZE (mm)	100*220*160
MATERIAL	DIECAST ALUMINIUM+PC
VOLTAGE	85-265V
CCT	3000K
CHIP	SANAN
BODY COLOUR	SAND DARK GREY/ SAND BLACK
IP RATING	IP 65



LED WALL LIGHT



**GF 126C**

WATTAGE	10W
SIZE (mm)	170*100
MATERIAL	DIECAST ALUMINIUM + GLASS
VOLTAGE	85-265V
CCT	3000K
CHIP	SANAN
BODY COLOUR	SAND DARK GREY
IP RATING	IP 65



LED WALL LIGHT



**GF 126F**

WATTAGE	5W
SIZE (mm)	65*112*130
MATERIAL	DIECAST ALUMINIUM
VOLTAGE	85-265V
CCT	3000K
CHIP	SANAN
BODY COLOUR	SAND DARK GREY
IP RATING	IP 65



**GF 126D**

WATTAGE	10W
SIZE (mm)	160*160*100
MATERIAL	DIECAST ALUMINIUM + GLASS
VOLTAGE	85-265V
CCT	3000K
CHIP	SANAN
BODY COLOUR	SAND DARK GREY
IP RATING	IP 65



**GF 126E**

WATTAGE	20W
SIZE (mm)	220*50
MATERIAL	DIECAST ALUMINIUM
VOLTAGE	85-265V
CCT	3000K
CHIP	SANAN
BODY COLOUR	SAND DARK GREY
IP RATING	IP 65



**GF 126G**

WATTAGE	5*2W
SIZE (mm)	65*112*160
MATERIAL	DIECAST ALUMINIUM
VOLTAGE	85-265V
CCT	3000K
CHIP	SANAN
BODY COLOUR	SAND DARK GREY
IP RATING	IP 65



**GF 125P**

WATTAGE	6*1W
SIZE (mm)	168*78*45
MATERIAL	DIECAST ALUMINIUM
VOLTAGE	85-265V
CCT	3000K
CHIP	BRIDGELUX-USA
BODY COLOUR	SAND DARK GREY
IP RATING	IP 65







**IGf 126Q**

WATTAGE	6W
SIZE (mm)	75*68*73
MATERIAL	DIECAST ALUMINIUM
VOLTAGE	85-265V
CCT	3000K
CHIP	BRIDGELUX-USA
BODY COLOUR	SAND DARK GREY
IP RATING	IP 65

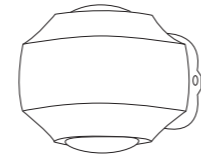

**IGf 126L**

WATTAGE	2*3W
SIZE (mm)	100*100*100
MATERIAL	DIECAST ALUMINIUM
VOLTAGE	85-265V
CCT	3000K
CHIP	BRIDGELUX-USA
BODY COLOUR	SAND DARK GREY
IP RATING	IP 65

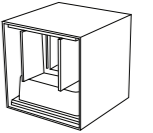
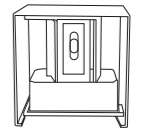

**IGf 126P**

WATTAGE	2*5W
SIZE (mm)	170*170*90
MATERIAL	DIECAST ALUMINIUM
VOLTAGE	85-265V
CCT	3000K
CHIP	BRIDGELUX-USA
BODY COLOUR	SAND DARK GREY
IP RATING	IP 65



**IGz 988**

WATTAGE	9W
SIZE (mm)	272*83*115
MATERIAL	DIECAST ALUMINIUM
VOLTAGE	85-265V
CCT	3000K
CHIP	SANAN
BODY COLOUR	SAND DARK GREY
IP RATING	IP 65





**GF 126M**

WATTAGE	2*3W
SIZE (mm)	134*100*120
MATERIAL	DIECAST ALUMINIUM
VOLTAGE	85-265V
CCT	3000K
CHIP	BRIDGELUX-USA
BODY COLOUR	SAND DARK GREY
IP RATING	IP 65



**GF 126N**

WATTAGE	2*5W
SIZE (mm)	170*170*90
MATERIAL	DIECAST ALUMINIUM
VOLTAGE	85-265V
CCT	3000K
CHIP	BRIDGELUX-USA
BODY COLOUR	DARK SAND GREY
IP RATING	IP 65



**GF 126H**

WATTAGE	5W
SIZE (mm)	65*112*130
MATERIAL	DIECAST ALUMINIUM
VOLTAGE	85-265V
CCT	3000K
CHIP	SANAN
BODY COLOUR	SAND DARK GREY
IP RATING	IP 65



**GF 126K**

WATTAGE	9W
SIZE (mm)	90*108*125
MATERIAL	DIECAST ALUMINIUM
VOLTAGE	85-265V
CCT	3000K
CHIP	BRIDGELUX-USA
BODY COLOUR	SAND DARK GREY
IP RATING	IP 65



**GF 125I**

WATTAGE	5*2W
SIZE (mm)	65*112*160
MATERIAL	DIECAST ALUMINIUM
VOLTAGE	85-265V
CCT	3000K
CHIP	SANAN
BODY COLOUR	SAND DARK GREY
IP RATING	IP 65



**GZ 989**

WATTAGE	6W
SIZE (mm)	90*160*55
MATERIAL	DIECAST ALUMINIUM
VOLTAGE	85-265V
CCT	3000K
CHIP	BRIDGELUX-USA
BODY COLOUR	SAND DARK GREY
IP RATING	IP 65





**IGF B717**

WATTAGE	6W
SIZE (mm)	220*112*50
MATERIAL	PC
VOLTAGE	85-265V
CCT	3000K
CHIP	SANAN
BODY COLOUR	GREY
IP RATING	IP 65

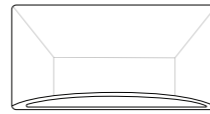

**IGF J906**

WATTAGE	5W
SIZE (mm)	54*66*54
MATERIAL	DIECAST ALUMINIUM
VOLTAGE	85-265V
CCT	3000K
CHIP	BRIDGELUX-USA
BODY COLOUR	DARK SAND GREY
IP RATING	IP 65

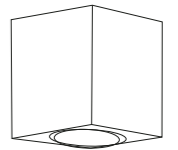

**IGF B716**

WATTAGE	12W
SIZE (mm)	230*110*76
MATERIAL	PC
VOLTAGE	85-265V
CCT	3000K
CHIP	SANAN
BODY COLOUR	GREY
IP RATING	IP 65





**IGF A905**

WATTAGE	2*3W
SIZE (mm)	90*160*65
MATERIAL	DIECAST ALUMINIUM
VOLTAGE	85-265V
CCT	3000K
CHIP	BRIDGELUX-USA
BODY COLOUR	DARK SAND GREY
IP RATING	IP 65



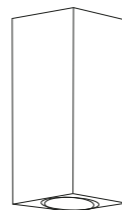

**IGF K906**

WATTAGE	2*5W
SIZE (mm)	54*56*100
MATERIAL	DIECAST ALUMINIUM
VOLTAGE	85-265V
CCT	3000K
CHIP	BRIDGELUX-USA
BODY COLOUR	SAND DARK GREY
IP RATING	IP 65

**IGF K905**

WATTAGE	2*5W
SIZE (mm)	75*100*90
MATERIAL	DIECAST ALUMINIUM
VOLTAGE	85-265V
CCT	3000K
CHIP	BRIDGELUX-USA
BODY COLOUR	OAK
IP RATING	IP 65

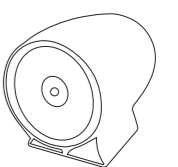

LED WALL LIGHT



**IGF G905**

WATTAGE	2*6W
SIZE (mm)	80*248*124
MATERIAL	DIECAST ALUMINIUM
VOLTAGE	85-265V
CCT	3000K
CHIP	SANAN
BODY COLOUR	DARK SAND GREY
IP RATING	IP 65



LED WALL LIGHT



**IGF M905**

WATTAGE	8W
SIZE (mm)	90*490*130
MATERIAL	DIECAST ALUMINIUM+PC
VOLTAGE	85-265V
CCT	3000K
CHIP	SANAN
BODY COLOUR	SAND DARK GREY
IP RATING	IP 65



**IGF L905**

WATTAGE	2*5W
SIZE (mm)	111*111*105
MATERIAL	DIECAST ALUMINIUM
VOLTAGE	85-265V
CCT	3000K
CHIP	SANAN
BODY COLOUR	DARK SAND GREY
IP RATING	IP 65



**IGF R905**

WATTAGE	7W
SIZE (mm)	109*159
MATERIAL	DIECAST ALUMINIUM
VOLTAGE	85-265V
CCT	3000K
CHIP	BRIDGELUX-USA
BODY COLOUR	DARK SAND GREY
IP RATING	IP 65





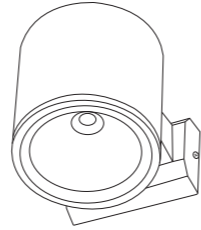

**IGF H905**

WATTAGE	2*9W
SIZE (mm)	90*108*125
MATERIAL	DIECAST ALUMINIUM
VOLTAGE	85-265V
CCT	3000K
CHIP	BRIGELUX-USA
BODY COLOUR	DARK SAND GREY
IP RATING	IP 65

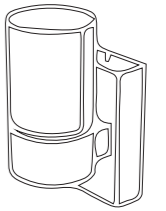

**IGF F905**

WATTAGE	6W
SIZE (mm)	80*195*124
MATERIAL	DIECAST ALUMINIUM + PC
VOLTAGE	85-265V
CCT	3000K
CHIP	SANAN
BODY COLOUR	DARK SAND GREY
IP RATING	IP 65



**IGF E905**

WATTAGE	3W
SIZE (mm)	148*148*35
MATERIAL	DIECAST ALUMINIUM
VOLTAGE	85-265V
CCT	3000K
CHIP	SANAN
BODY COLOUR	DARK SAND GREY
IP RATING	IP 65





**IGF B905**

WATTAGE	5W
SIZE (mm)	80*100*68
MATERIAL	DIECAST ALUMINIUM
VOLTAGE	85-265V
CCT	3000K
CHIP	BRIDGELUX-USA
BODY COLOUR	DARK SAND GREY
IP RATING	IP 65



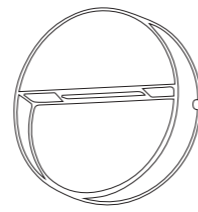

**IGF D905**

WATTAGE	3W
SIZE (mm)	148*35
MATERIAL	DIECAST ALUMINIUM
VOLTAGE	85-265V
CCT	3000K
CHIP	SANAN
BODY COLOUR	DARK SAND GREY
IP RATING	IP 65



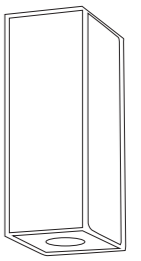

**IGF C905**

WATTAGE	2*5W
SIZE (mm)	80*160*68
MATERIAL	DIECAST ALUMINIUM
VOLTAGE	85-265V
CCT	3000K
CHIP	SANAN
BODY COLOUR	DARK SAND GREY
IP RATING	IP 65



WALL LIGHT



**GF 855**

POWER	2*E27
SIZE (mm)	460*310
MATERIAL	ALUMINUM + GLASS
VOLTAGE	100-240V
IP RATING	IP55
BODY COLOUR	BRONZE

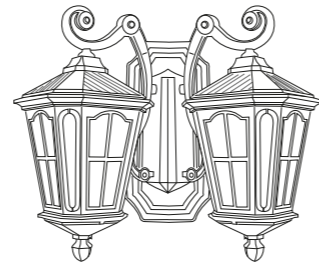



WALL LIGHT

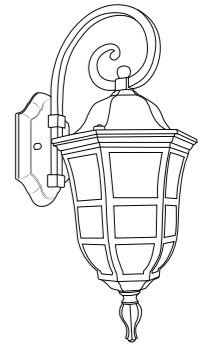

**GF 823**

POWER	1*E27
SIZE (mm)	235*205*450
MATERIAL	ALUMINUM + GLASS
VOLTAGE	100-240V
IP RATING	IP55
BODY COLOUR	BROWN

**GF 854**

POWER	1*E27
SIZE (mm)	180*380
MATERIAL	ALUMINUM + GLASS
VOLTAGE	100-240V
IP RATING	IP55
BODY COLOUR	BRONZE





**IGD 72A**

POWER	1*E27
SIZE (mm)	200*205*395
MATERIAL	ALUMINUM + GLASS
VOLTAGE	100-240V
IP RATING	IP55
BODY COLOUR	BLACK

**GF 852**

POWER	1*E27
SIZE (mm)	180*380
MATERIAL	ALUMINUM + GLASS
VOLTAGE	100-240V
IP RATING	IP55
BODY COLOUR	BLACK

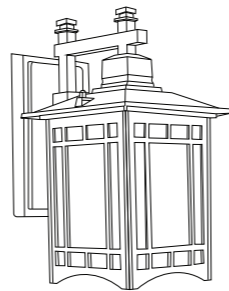

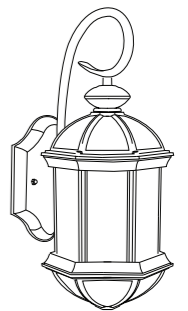

**IGD 72G**

POWER	1*E27
SIZE (mm)	200*160*390
MATERIAL	ALUMINUM + GLASS
VOLTAGE	100-240V
IP RATING	IP55
BODY COLOUR	BLACK





WALL LIGHT

**GZ 574**

POWER	1*E27
SIZE (mm)	260*230*190
MATERIAL	ALUMINUM + GLASS
VOLTAGE	100-240V
IP RATING	IP55
BODY COLOUR	BLACK



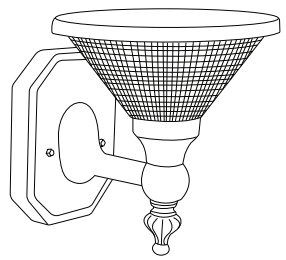

**GZ 566**

POWER	E27
SIZE (mm)	240*180*300
MATERIAL	ALUMINUM + GLASS
VOLTAGE	100-240V
IP RATING	IP55
BODY COLOUR	BLACK

**GF 853**

POWER	E27
SIZE (mm)	240*380
MATERIAL	ALUMINUM + GLASS
VOLTAGE	100-240V
IP RATING	IP55
BODY COLOUR	BRONZE

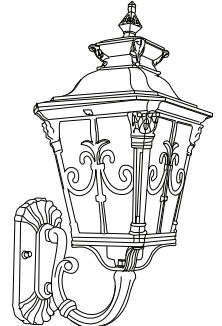



**IGZ-971**

POWER SOURCE 1\*E27  
SIZE(mm) 180\*330  
MATERIAL COPPER+GLASS



**IGZ-974**

POWER SOURCE 1\*E27  
SIZE(mm) 160\*370  
MATERIAL COPPER+GLASS



**IGZ-972**

POWER SOURCE 1\*E27  
SIZE(mm) 180\*360  
MATERIAL COPPER+GLASS



**IGF-432**

POWER SOURCE 3\*E14  
SIZE(mm) 240\*500  
MATERIAL COPPER+GLASS



**IGF-433**

POWER SOURCE 3\*E14  
SIZE(mm) 200\*650  
MATERIAL COPPER+GLASS



**IGF-426**

POWER SOURCE 1\*E27  
SIZE(mm) 160\*310  
MATERIAL COPPER+GLASS



**IGZ-973**

POWER SOURCE 1\*E27  
SIZE(mm) 160\*370  
MATERIAL COPPER+GLASS



**IGZ-975**

POWER SOURCE 1\*E27  
SIZE(mm) 170\*450  
MATERIAL COPPER+GLASS



**IGF-431**

POWER SOURCE 1\*E27  
SIZE(mm) 160\*500  
MATERIAL COPPER+GLASS



**IGF-99B**

POWER SOURCE 1\*E27  
SIZE(mm) 150\*225  
MATERIAL COPPER+GLASS



**IGF-99C**

POWER SOURCE 2\*E27  
SIZE(mm) 150\*425  
MATERIAL COPPER+GLASS





**IGZ 492**

WATTAGE 12W  
 SIZE (mm) 150\*230  
 MATERIAL ALUMINIUM  
 VOLTAGE 85-265V  
 CCT 3000K  
 CHIP BRIDGELUX-USA  
 IP RATING IP65  
 BODY COLOUR STONE GREY

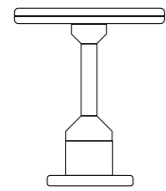

LED BOLLARD LIGHT



**IGZ 494**

WATTAGE 12W  
 SIZE (mm) 150\*150\*230  
 MATERIAL ALUMINIUM  
 VOLTAGE 85-265V  
 CCT 3000K  
 CHIP BRIDGELUX-USA  
 IP RATING IP65  
 BODY COLOUR STONE GREY

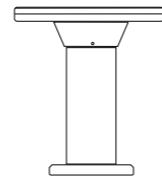

LED BOLLARD LIGHT



**IGF S906**

WATTAGE 7W/12W  
 SIZE (mm) 160\*160\*200/300\*300\*250  
 MATERIAL ALUMINIUM  
 VOLTAGE 85-265V  
 CCT 3000K  
 CHIP BRIDGELUX-USA  
 IP RATING IP65  
 BODY COLOUR SAND DARK GREY

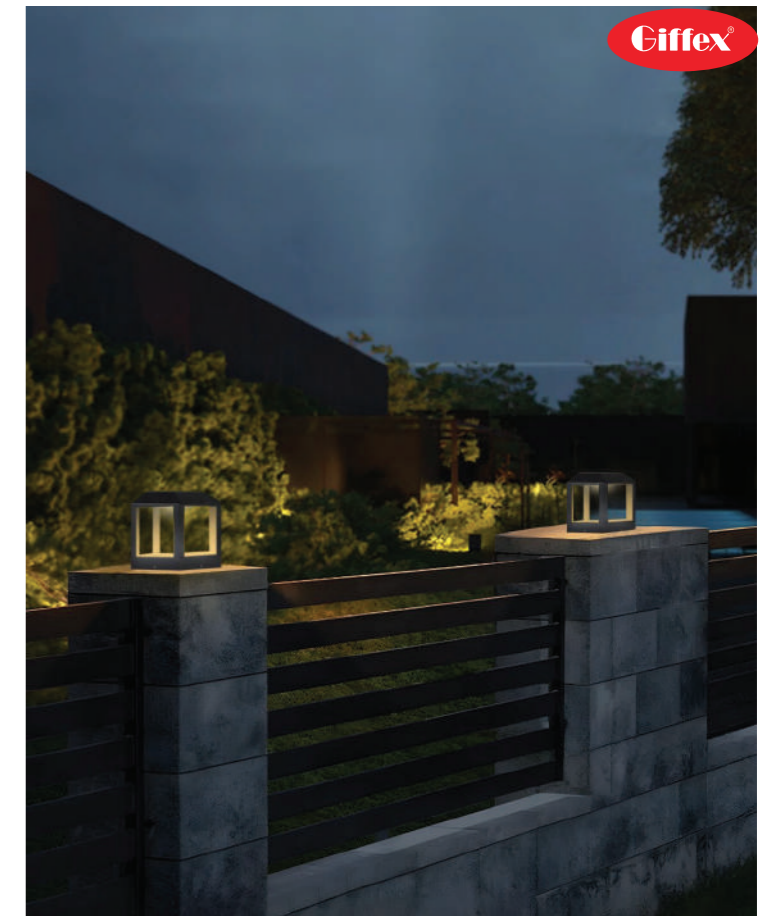
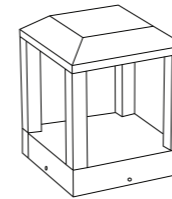

**IGZ 496**

WATTAGE 7W  
 SIZE (mm) 106\*106\*200  
 MATERIAL ALUMINIUM  
 VOLTAGE 85-265V  
 CCT 3000K  
 CHIP BRIDGELUX-USA  
 IP RATING IP65  
 BODY COLOUR STONE GREY

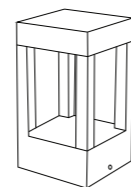

**IGZ 994A**

WATTAGE 7W  
 SIZE (mm) 150\*150\*200  
 MATERIAL ALUMINIUM  
 VOLTAGE 85-265V  
 CCT 3000K  
 CHIP SANAN  
 IP RATING IP65  
 BODY COLOUR SAND DARK GREY

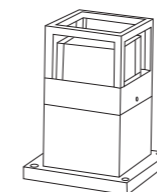

**IGF C906**

WATTAGE 7W  
 SIZE (mm) 90\*200  
 MATERIAL ALUMINIUM  
 VOLTAGE 85-265V  
 CCT 3000K  
 CHIP BRIDGELUX-USA  
 IP RATING IP65  
 BODY COLOUR SAND DARK GREY





**IGF A906**

WATTAGE	7W
SIZE (mm)	110*110*200
MATERIAL	ALUMINIUM
VOLTAGE	85-265V
CCT	3000K
CHIP	BRIDGELUX-USA
IP RATING	IP65
BODY COLOUR	SAND DARK GREY

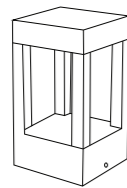

LED BOLLARD LIGHT



**IGG 14A**

WATTAGE	7W
SIZE (mm)	150*200
MATERIAL	ALUMINIUM
VOLTAGE	85-265V
CCT	3000K
CHIP	SANAN
IP RATING	IP65
BODY COLOUR	SAND DARK GREY

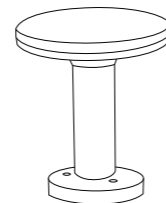

**IGG 14B**

WATTAGE	7W
SIZE (mm)	150*150*200
MATERIAL	ALUMINIUM
VOLTAGE	85-265V
CCT	3000K
CHIP	SANAN
IP RATING	IP65
BODY COLOUR	SAND DARK GREY

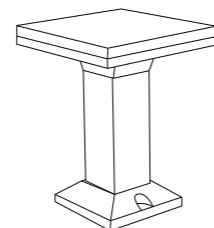

LED BOLLARD LIGHT



**IGG 14F**

WATTAGE	7W
SIZE (mm)	100*200
MATERIAL	ALUMINIUM
VOLTAGE	85-265V
CCT	3000K
CHIP	SANAN
IP RATING	IP65
BODY COLOUR	SAND DARK GREY

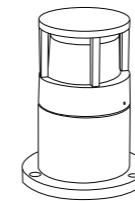

**IGG 14E**

WATTAGE	7W
SIZE (mm)	150*150*200
MATERIAL	ALUMINIUM
VOLTAGE	85-265V
CCT	3000K
CHIP	SANAN
IP RATING	IP65
BODY COLOUR	SAND DARK GREY

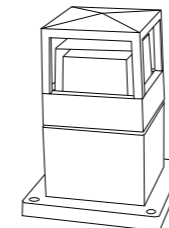

**IGZ 995A**

WATTAGE	7W
SIZE (mm)	140*120*200
MATERIAL	ALUMINIUM
VOLTAGE	85-265V
CCT	3000K
CHIP	BRIDGELUX-USA
IP RATING	IP65
BODY COLOUR	SAND DARK GREY

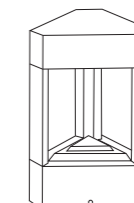



**|GZ 565**

SIZE (mm) 180\*180\*360  
 MATERIAL ALUMINIUM + GLASS  
 VOLTAGE 110-240V  
 POWER SOURCE E27  
 IP RATING IP55  
 BODY COLOUR BLACK

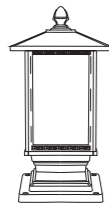

BOLLARD LIGHT



**|GF 830**

SIZE (mm) 150\*425  
 MATERIAL ALUMINIUM + GLASS  
 VOLTAGE 110-240V  
 POWER SOURCE E27  
 IP RATING IP55  
 BODY COLOUR BLACK



**|GF 826**

SIZE (mm) 205\*460/250\*586  
 MATERIAL ALUMINIUM + GLASS  
 VOLTAGE 100-240V  
 POWER SOURCE E27  
 IP RATING IP55  
 BODY COLOUR COFFEE



BOLLARD LIGHT



**|GF T905**

SIZE (mm) 300\*300\*300  
 MATERIAL ALUMINIUM + GLASS  
 VOLTAGE 85-265V  
 POWER SOURCE E27  
 IP RATING IP55  
 BODY COLOUR SAND DARK GREY

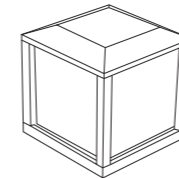

**|GF 849**

SIZE (cm) 200\*450  
 MATERIAL ALUMINIUM + GLASS  
 VOLTAGE 100-240V  
 POWER SOURCE E27  
 IP RATING IP55  
 BODY COLOUR COFFEE



**|GZ 972A**

SIZE (mm) 220\*400  
 MATERIAL COPPER + GLASS  
 VOLTAGE 100-240V  
 POWER SOURCE E27  
 IP RATING IP55  
 BODY COLOUR BRASS



LED BOLLARD LIGHT



**IGZ 504**

WATTAGE 12W  
 SIZE (mm) 170\*140\*600  
 MATERIAL DIECAST ALUMINIUM  
 VOLTAGE 85-265V  
 CCT 3000K  
 CHIP BRIDGELUX-USA  
 IP RATING IP65  
 BODY COLOUR STONE GREY



LED BOLLARD LIGHT



**IGZ 679**

WATTAGE 9+5W  
 SIZE (mm) 140\*500  
 MATERIAL DIECAST ALUMINIUM  
 VOLTAGE 85-265V  
 CCT 3000K  
 CHIP BRIDGELUX-USA  
 IP RATING IP65  
 BODY COLOUR STONE GREY



**IGZ 497**

WATTAGE 7W  
 SIZE (mm) 110\*106\*600  
 MATERIAL DIECAST ALUMINIUM  
 VOLTAGE 85-265V  
 CCT 3000K  
 CHIP BRIDGELUX-USA  
 IP RATING IP65  
 BODY COLOUR STONE GREY



**IGZ 493**

WATTAGE 12W  
 SIZE (mm) 150\*600  
 MATERIAL DIECAST ALUMINIUM  
 VOLTAGE 85-265V  
 CCT 3000K  
 CHIP BRIDGELUX-USA  
 IP RATING IP65  
 BODY COLOUR STONE GREY



**IGG 75B**

WATTAGE 9W  
 SIZE (mm) 140\*600  
 MATERIAL DIECAST ALUMINIUM  
 VOLTAGE 85-265V  
 CCT 3000K  
 CHIP BRIDGELUX-USA  
 IP RATING IP65  
 BODY COLOUR STONE GREY



**IGZ 495**

WATTAGE 12W  
 SIZE (mm) 150\*150\*600  
 MATERIAL DIECAST ALUMINIUM  
 VOLTAGE 85-265V  
 CCT 3000K  
 CHIP BRIDGELUX-USA  
 IP RATING IP65  
 BODY COLOUR STONE GREY



LED BOLLARD LIGHT



**GZ 498**

WATTAGE 5W  
 SIZE (mm) 105\*600  
 MATERIAL DIECAST ALUMINIUM  
 VOLTAGE 85-265V  
 CCT 3000K  
 CHIP BRIDGELUX-USA  
 I.P RATING IP65  
 BODY COLOUR STONE GREY



LED BOLLARD LIGHT



**GZ 685**

WATTAGE 6W  
 SIZE (mm) 105\*105\*600  
 MATERIAL DIECAST ALUMINIUM  
 VOLTAGE 85-265V  
 CCT 3000K  
 CHIP BRIDGELUX-USA  
 I.P RATING IP65  
 BODY COLOUR STONE GREY



**GZ 697**

WATTAGE 6W  
 SIZE (mm) 205\*120\*600  
 MATERIAL DIECAST ALUMINIUM  
 VOLTAGE 85-265V  
 CCT 3000K  
 CHIP BRIDGELUX-USA  
 I.P RATING IP65  
 BODY COLOUR STONE GREY



**GZ 686**

WATTAGE 2\*6W  
 SIZE (mm) 210\*105\*635  
 MATERIAL DIECAST ALUMINIUM  
 VOLTAGE 85-265V  
 CCT 3000K  
 CHIP BRIDGELUX-USA  
 I.P RATING IP65  
 BODY COLOUR STONE GREY



**GZ 696**

WATTAGE 6W  
 SIZE (mm) 205\*120\*600  
 MATERIAL DIECAST ALUMINIUM  
 VOLTAGE 85-265V  
 CCT 3000K  
 CHIP BRIDGELUX-USA  
 I.P RATING IP65  
 BODY COLOUR STONE GREY



**GZ 691**

WATTAGE 6W  
 SIZE (mm) 175\*90\*600  
 MATERIAL DIECAST ALUMINIUM  
 VOLTAGE 85-265V  
 CCT 3000K  
 CHIP BRIDGELUX-USA  
 I.P RATING IP65  
 BODY COLOUR STONE GREY





LED BOLLARD LIGHT



**IGZ 677**

WATTAGE	12W
SIZE (mm)	150*600
MATERIAL	DIECAST ALUMINIUM
VOLTAGE	85-265V
CCT	3000K
CHIP	BRIDGELUX-USA
IP RATING	IP65
BODY COLOUR	STONE GREY



**IGZ 678**

WATTAGE	12W
SIZE (mm)	150*600
MATERIAL	DIECAST ALUMINIUM
VOLTAGE	85-265V
CCT	3000K
CHIP	BRIDGELUX-USA
IP RATING	IP65
BODY COLOUR	STONE GREY



LED BOLLARD LIGHT



IGG 14C

WATTAGE 7W  
 SIZE (mm) 150\*150\*600  
 MATERIAL DIECAST ALUMINIUM  
 VOLTAGE 85-265V  
 CCT 3000K  
 CHIP SANAN  
 IP RATING IP65  
 BODY COLOUR SAND DARK GREY



LED BOLLARD LIGHT



IGG 15B

WATTAGE 12W  
 SIZE (mm) 180\*180\*600  
 MATERIAL DIECAST ALUMINIUM  
 VOLTAGE 85-265V  
 CCT 3000K  
 CHIP SANAN  
 IP RATING IP65  
 BODY COLOUR SAND DARK GREY



IGG 14D

WATTAGE 7W  
 SIZE (mm) 150\*150\*600  
 MATERIAL DIECAST ALUMINIUM  
 VOLTAGE 85-265V  
 CCT 3000K  
 CHIP SANAN  
 IP RATING IP65  
 BODY COLOUR BLACK



IGZ 994B

WATTAGE 12W  
 SIZE (mm) 150\*150\*600  
 MATERIAL DIECAST ALUMINIUM  
 VOLTAGE 85-265V  
 CCT 3000K  
 CHIP SANAN  
 IP RATING IP65  
 BODY COLOUR SAND DARK GREY



IGG 14G

WATTAGE 7W  
 SIZE (mm) 150\*600  
 MATERIAL DIECAST ALUMINIUM  
 VOLTAGE 85-265V  
 CCT 3000K  
 CHIP SANAN  
 IP RATING IP65  
 BODY COLOUR SAND DARK GREY



IGF G906

WATTAGE 8/20W  
 SIZE (mm) 65\*430/65\*830  
 MATERIAL DIECAST ALUMINIUM+PC  
 VOLTAGE 85-265V  
 CCT 3000K  
 CHIP SANAN  
 IP RATING IP65  
 BODY COLOUR SAND DARK GREY



LED BOLLARD LIGHT



**IGF E906**

WATTAGE 7W  
 SIZE (mm) 165\*55\*300/600  
 MATERIAL DIECAST ALUMINIUM  
 VOLTAGE 85-265V  
 CCT 3000K  
 CHIP BRIDGELUX-USA  
 IP RATING IP65  
 BODY COLOUR SAND DARK GREY



LED BOLLARD LIGHT



**IGF 126R**

WATTAGE 7W  
 SIZE (mm) 150\*150\*900  
 MATERIAL DIECAST ALUMINIUM  
 VOLTAGE 85-265V  
 CCT 3000K  
 CHIP SANAN  
 IP RATING IP65  
 BODY COLOUR SAND DARK GREY



**IGF D906**

WATTAGE 12W  
 SIZE (mm) 90\*600  
 MATERIAL DIECAST ALUMINIUM  
 VOLTAGE 85-265V  
 CCT 3000K  
 CHIP BRIDGELUX-USA  
 IP RATING IP65  
 BODY COLOUR SAND DARK GREY



**IGF 846**

SIZE (mm) 180\*860  
 MATERIAL DIECAST ALUMINIUM+GLASS  
 POWER SOURCE E27  
 VOLTAGE 110-240V  
 IP RATING IP65  
 BODY COLOUR COFFEE



**IGF B906**

WATTAGE 7W  
 SIZE (mm) 110\*110\*600  
 MATERIAL DIECAST ALUMINIUM  
 VOLTAGE 85-265V  
 CCT 3000K  
 CHIP BRIDGELUX-USA  
 IP RATING IP65  
 BODY COLOUR SAND DARK GREY



**IGF 827**

SIZE (mm) 205\*1050  
 MATERIAL DIECAST ALUMINIUM+GLASS  
 POWER SOURCE E27  
 VOLTAGE 110-240V  
 IP RATING IP65  
 BODY COLOUR BROWN







Ciffex

LED BRICK LIGHT

IGF A681

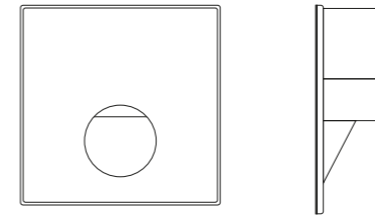

WATTAGE	3W
SIZE (mm)	L*W*H 86*83*37
CUT OUT	2MD

Ciffex



INPUT	AC 110-240V	BODY COLOUR	SAND BLACK	W	3000K
MATERIAL	ALUMINIUM				
CHIP	CREE				

LED BULKHEAD

IHALA



IP RATING	IP64
WORKING VOLTAGE	85-285V
CRI	80
CCT	6500k, 4000k
CHIP	SANAN
MATERIAL	FIBER
SHAPE	OVAL



WATTAGE	12W	18W	24W
SIZE	190*85*50	225*105*55	265*125*58

IHAYA



IP RATING	IP64
WORKING VOLTAGE	85-285V
CRI	80
CCT	6500k, 4000k
CHIP	SANAN
MATERIAL	FIBER
SHAPE	ROUND

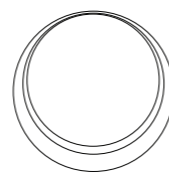

WATTAGE	18W	24W
SIZE	168*168*65	195*195*70

IGF A682

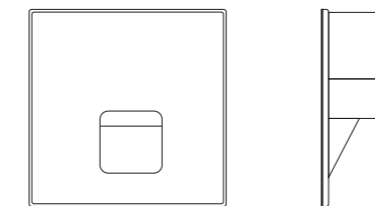

WATTAGE	3W
SIZE (mm)	L*W*H 86*83*37
CUT OUT	2MD



INPUT	AC 110-240V	BODY COLOUR	SAND BLACK	W	3000K
MATERIAL	ALUMINIUM				
CHIP	CREE				

LED BRICK LIGHT

IGF A683

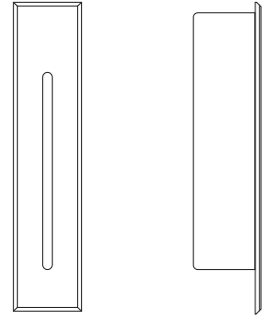

WATTAGE	3W
SIZE (mm) L*W*H	185*40*51
CUT OUT (mm)	160*35



INPUT	AC 110-240V	BODY COLOUR	SAND BLACK	W	3000K
MATERIAL	ALUMINIUM				
CHIP	CREE				



LED BRICK LIGHT

IGG 76A

WATTAGE	2W
SIZE (mm)	55*55*48
CCT	3000K
MATERIAL	DIECAST ALUMINIUM
VOLTAGE	85-265V
CHIP	BRIDGELUX-USA
BODY COLOUR	STONE GREY

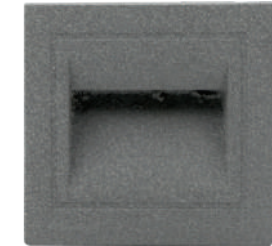
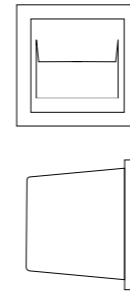

IGG 76B

WATTAGE	3W
SIZE (mm)	80*85
CCT	3000K
MATERIAL	DIECAST ALUMINIUM
VOLTAGE	85-265V
CHIP	BRIDGELUX-USA
BODY COLOUR	STONE GREY

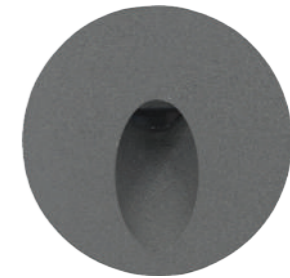
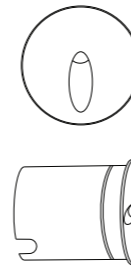

IGG 76E

WATTAGE	6W
SIZE	214*85*50
CCT	3000K
MATERIAL	DIECAST ALUMINIUM
VOLTAGE	85-265V
CHIP	BRIDGELUX-USA
BODY COLOUR	STONE GREY

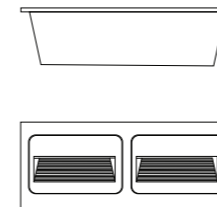

LED BRICK LIGHT

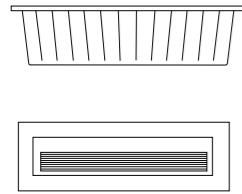

**GX 1753**

WATTAGE 6W  
 SIZE (mm) 210\*65\*63  
 CCT 3000K  
 MATERIAL DIECAST ALUMINIUM  
 VOLTAGE 85-265V  
 CHIP BRIDGELUX-USA  
 BODY COLOUR STONE GREY

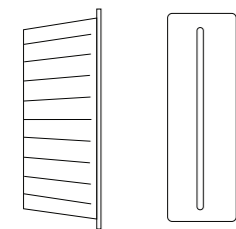

**GE 83**

WATTAGE 3W  
 SIZE (mm) 180\*58\*80  
 CCT 3000K  
 MATERIAL DIECAST ALUMINIUM  
 VOLTAGE 85-265V  
 CHIP BRIDGELUX-USA  
 BODY COLOUR STONE GREY



LED BRICK LIGHT

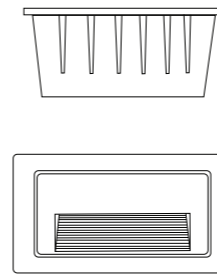

**GE 88A**

WATTAGE 3W  
 SIZE (mm) 104\*60\*53  
 CCT 3000K  
 MATERIAL DIECAST ALUMINIUM  
 VOLTAGE 85-265V  
 CHIP SANAN  
 BODY COLOUR SAND DARK GREY

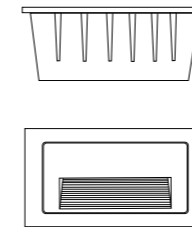
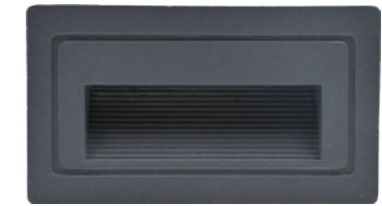

**GE 88B**

WATTAGE 5W  
 SIZE (mm) 146\*86\*54  
 CCT 3000K  
 MATERIAL DIECAST ALUMINIUM  
 VOLTAGE 85-265V  
 CHIP SANAN  
 BODY COLOUR SAND DARK GREY

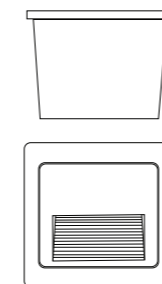

**GE 88D**

WATTAGE 3W  
 SIZE 85\*85\*50  
 CCT 3000K  
 MATERIAL DIECAST ALUMINIUM  
 VOLTAGE 85-265V  
 CHIP SANAN  
 BODY COLOUR SAND DARK GREY

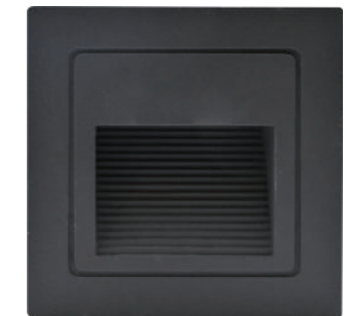

## LED BRICK LIGHT

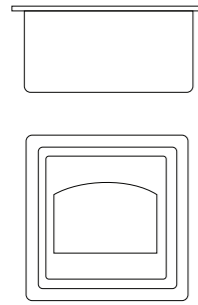

### GE 88E

WATTAGE	3W
SIZE (mm)	85*85*50
CCT	3000K
MATERIAL	DIECAST ALUMINIUM
VOLTAGE	85-265V
CHIP	SANAN
BODY COLOUR	SAND DARK GREY

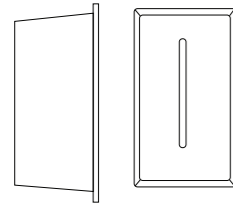

### GE 88G

WATTAGE	3W
SIZE (mm)	103*58*53
CCT	3000K
MATERIAL	DIECAST ALUMINIUM
VOLTAGE	85-265V
CHIP	SANAN
BODY COLOUR	SAND DARK GREY

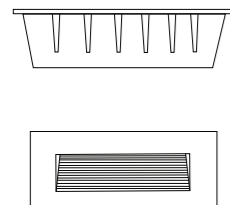

### GE 88H

WATTAGE	3W
SIZE	110*45*55
CCT	3000K
MATERIAL	DIECAST ALUMINIUM
VOLTAGE	85-265V
CHIP	SANAN
BODY COLOUR	SAND DARK GREY



## LED SPIKE LIGHT

### EVA

WATTAGE	5W / 12W
SIZE	95*110*132
CCT	w c e
CRI	>80
MATERIAL	ALUMINIUM
IP RATING	IP65
CHIP	SANAN
INPUT VOLTAGE	85-265V
BEAM ANGLE	60°

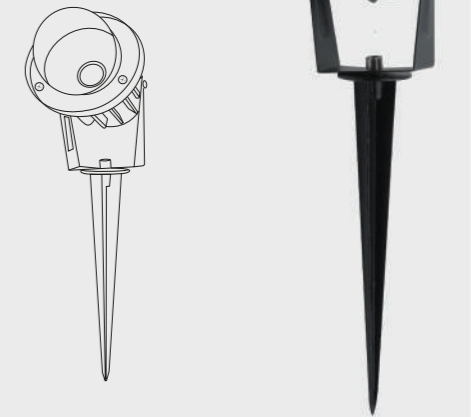

### YURI

WATTAGE	3W	12W
SIZE	70*130*150	95*110*142
CCT	w c e	
CRI	>80	
MATERIAL	ALUMINIUM	
IP RATING	IP65	
CHIP	SANAN	
INPUT VOLTAGE	85-265V	
BEAM ANGLE	60°	





LED INGROUND LIGHT

**FURBO**

MATERIAL PC + STAINLESS STEEL  
 CCT 3000K  
 IP RATING IP 67  
 CHIP SANAN  
 CRI 70  
 SHAPE ROUND  
 BODY COLOUR SILVER



WATTAGE	3W	6W
SIZE (mm)	75*89.5	89*99.5
CUTOUT (mm)	65	75

**ELEGANCE**

MATERIAL STEEL + ABS  
 CCT 3000K  
 IP RATING IP 67  
 CHIP SANAN  
 CRI 70  
 SHAPE ROUND  
 BODY COLOUR SILVER



WATTAGE	1W	3W	5W
SIZE (mm)	64*74	64*74	80*74
CUTOUT (mm)	57	57	73

# IZAILA

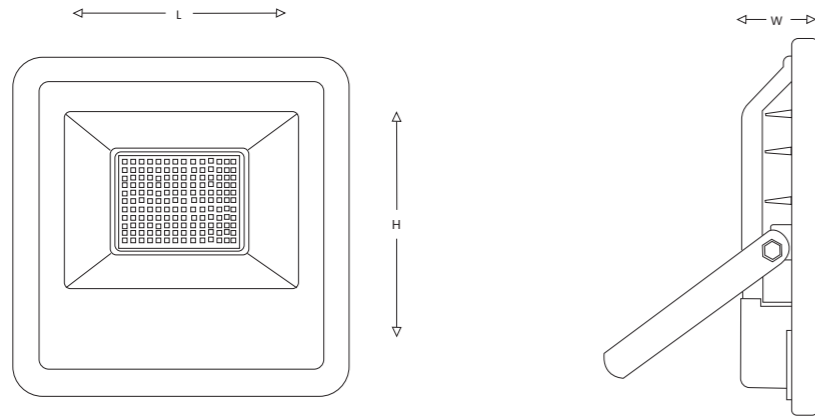
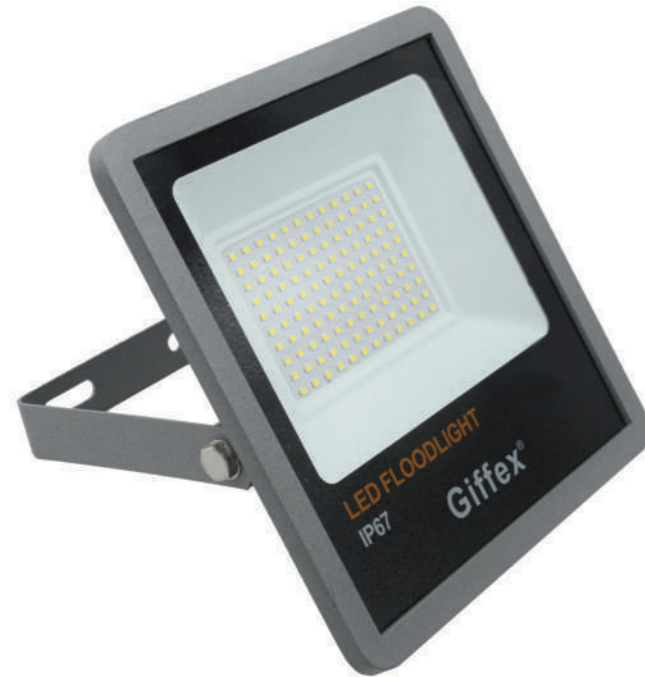

WATTAGE	20W	30W	50W	100W	150W	200W
SIZE (mm) L*H*W	192*175*35	192*175*35	223*210*43	276*256*54	310*280*62	350*320*62

MATERIAL	ALUMINIUM
CHIP	EPISTAR
PF/ SURGE	0.95/4.0 KV
IP RATING	IP 67

- C 6500K
- N 4000K
- W 3000K

CRI	INPUT	BODY COLOUR	BEAM ANGLES
>80	AC 85-265V	STONE GREY	120°

# IDINA

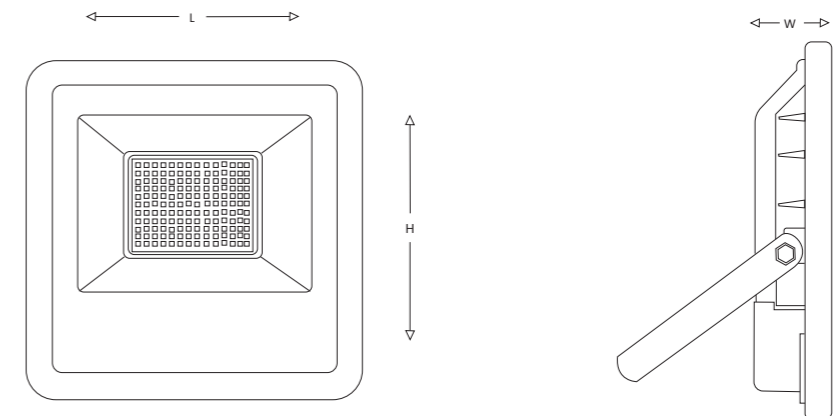

WATTAGE	10W	20W	30W	50W	100W	150W	200W
SIZE (mm) L*H*W	125*117*37	150*140*40	180*170*40	245*235*61	280*270*65	310*300*72	345*335*84

MATERIAL	ALUMINIUM
CHIP	EPISTAR
PF/ SURGE	0.95/4.0 KV
PF/ SURGE	IP 65

- C 6500K
- N 4000K
- W 3000K

CRI	INPUT	BODY COLOUR	BEAM ANGLES
>80	AC 100-265V	BLACK	120°



LED UFO HIGHBAY LIGHT

# IGHIATH

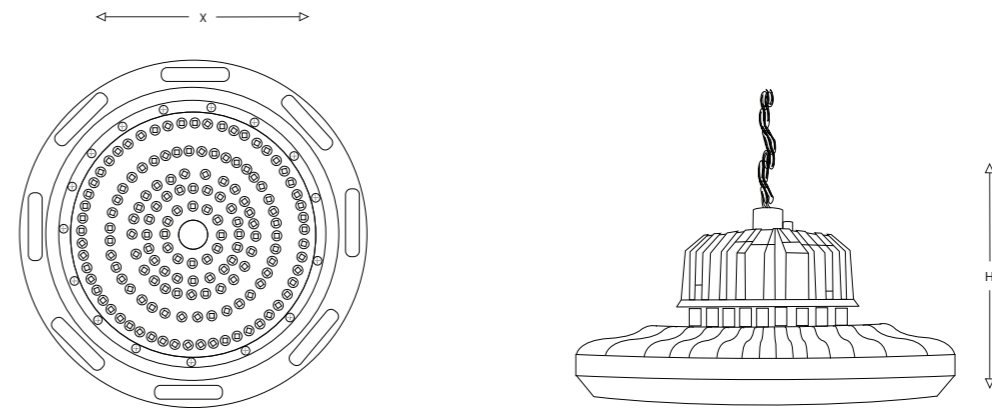

WATTAGE	100W	150W	200W	240W
SIZE (mm) X*H	255*112	304*118	350*158	370*158

MATERIAL	ALUMINIUM
CHIP	EPISTAR
PF/ SURGE	0.95/4.0 KV
IP RATING	IP 65

- C 6500K
- N 4000K

CRI	INPUT
>70	AC 100-265V

BODY COLOUR
BLACK





PENDANT LIGHT



GF 848

SIZE (mm)	200*300
MATERIAL	DIECAST ALUMINIUM + GLASS
POWER SOURCE	1*E27
VOLTAGE	100-240V
IP RATING	IP55
BODY COLOUR	COFFEE

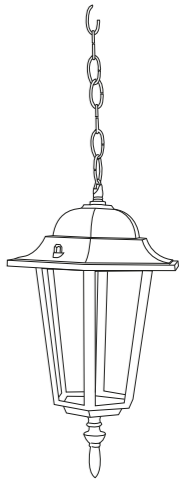

GF 824

SIZE (mm)	205*380
MATERIAL	DIECAST ALUMINIUM + GLASS
POWER SOURCE	1*E27
VOLTAGE	100-240V
IP RATING	IP55
BODY COLOUR	BROWN

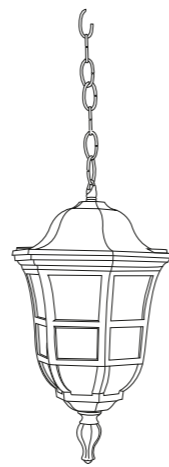

GF 831

SIZE (mm)	150*300
MATERIAL	DIECAST ALUMINIUM + GLASS
POWER SOURCE	1*E27
VOLTAGE	100-240V
IP RATING	IP55
BODY COLOUR	BLACK

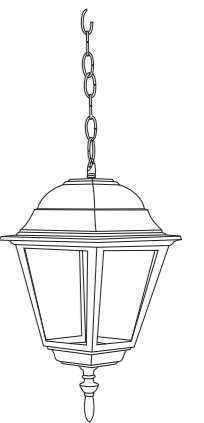





### GARDEN LIGHT

#### IGF 832

SIZE (mm)	550*2400
MATERIAL	DIECAST ALUMINIUM
POWER SOURCE	2*E27
VOLTAGE	100-240V
IP RATING	IP55
BODY COLOUR	BLACK+GOLD

#### IGF 850

SIZE (mm)	500*2200
MATERIAL	DIECAST ALUMINIUM
POWER SOURCE	3*E27
VOLTAGE	100-240V
IP RATING	IP55
BODY COLOUR	COFFEE



**IGF 851**

SIZE (mm) 450\*2200  
 MATERIAL DIECAST ALUMINIUM  
 POWER SOURCE 2\*E27  
 VOLTAGE 100-240V  
 IP RATING IP55  
 BODY COLOUR COFFEE

**IGF 857**

SIZE (mm) 590\*2500  
 MATERIAL DIECAST ALUMINIUM  
 POWER SOURCE 2\*E27  
 VOLTAGE 100-240V  
 IP RATING IP55  
 BODY COLOUR BRONZE

**IGF 858**

SIZE (mm) 800\*2400  
 MATERIAL DIECAST ALUMINIUM  
 POWER SOURCE 2\*E27  
 VOLTAGE 100-240V  
 IP RATING IP55  
 BODY COLOUR BLACK

**IGF 859**

SIZE (mm) 400\*2400  
 MATERIAL DIECAST ALUMINIUM  
 POWER SOURCE 1\*E27  
 VOLTAGE 100-240V  
 IP RATING IP55  
 BODY COLOUR BLACK

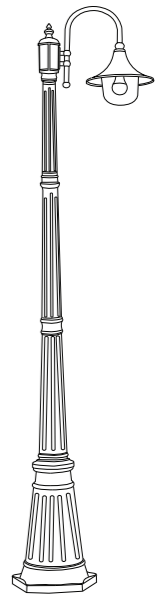
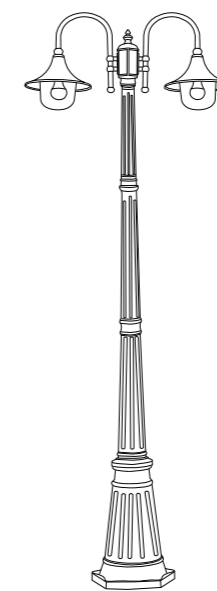
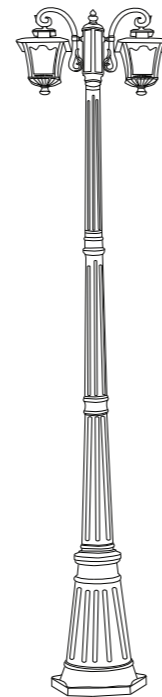
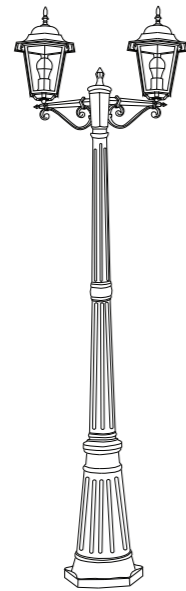



GARDEN LIGHT

GG 786

SIZE (mm)	550*2300
MATERIAL	DIECAST ALUMINIUM
POWER SOURCE	2*E27
VOLTAGE	100-240V
IP RATING	IP55
BODY COLOUR	BLACK

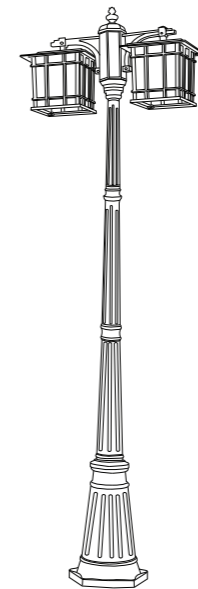

GF 828

SIZE (mm)	550*2400
MATERIAL	ALUMINIUM
POWER SOURCE	2*E27
VOLTAGE	100-240V
IP RATING	IP55
BODY COLOUR	BROWN

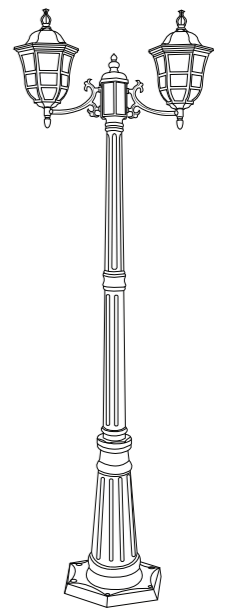



Don't hesitate to reach out if you have any questions or need further assistance.